



Authorized Distributor:



GULF
MINETECH™

Tel: +971 4 880 1252

Email: inquiries@gulfminetech.com

W: www.gulfminetech.com

LIGHTS FOR HEAVY
DUTY VEHICLES



CONTENT

INTRODUCTION	02
LED SERIES	06
MIRAGE -NEW!	08
XTR/PRO SERIES	12
SCORPIUS	12
CANIS	26
PHENOM OPTICS EQUIPPED	30
GO SERIES	34
SCORPIUS GO	36
CANIS GO	38
SATO GO	40
KL SERIES	42
SPECIAL LIGHTS	50
SATO 725 -NEW!	50
GEMINI	52
PICTOR	56
TAURUS	60
SAFETY LIGHTS	62
VELA	62
REAR LIGHTS	64
CORONA 400	64
DORADO	66
FRONT LIGHTS	68
BUMBLEBEE	68
CUE	70
SCULPTOR	72
N5XX	74
WARRANTY & ABBREVIATIONS	76

WE CREATE OPTIMAL VISIBILITY

Nordic Lights was founded in the darkness of the Finnish forests, where the need for illumination came out of pure necessity. During the years, we have learned just what it takes to develop the perfect work lights for every work site. Working closely with industry leading manufacturers of heavy-duty vehicles has given us a pro-found understanding of the everyday challenges that machine operators face.

We take pride in our in-house R&D department with modern light and testing labs, and the latest in simulation software. This enables us to stay ahead of the game, be creative and develop products according to very high standards. We have the best product developers and engineers, who are constantly designing world-class lighting solutions. And we have the best production team vouching for the uniquely low failure rate of our production.

Today, we can claim to be the world's best producer of lights for heavy-duty vehicles. We develop, design, manufacture, and test all of our work light series in our own factory in Finland. This way we ensure that every part of the process is fine-tuned to perfection.

The use of NORDIC LIGHTS® work lights on your heavy-duty equipment is a brilliant choice. You will get superior durability, low maintenance, and the best available technology backed by extensive testing. It is important to us to offer the ideal lighting solution to each customer. The light is optimized for the specific equipment or use by different combinations of light patterns, brackets, dampeners, and cable connectors. You can choose your LED work light from our extensive product range, or we can customize it for you.

In the introduction to our product range found in this brochure you will find the product's key facts, such as technical data and light patterns. If you would like to find out more about the What, How, and Why, please visit nordiclights.com.





THIS IS HOW WE ROLL

Making Outstanding Lights for Heavy-Duty Vehicles

We make sure your product is truly ready for heavy-duty use. We will help you gain an optimal light level and even light distribution to improve efficiency and safety on the worksite. All our lights are premium products, sturdy and reliable. They are put through extensive testing before passing inspection. These tests include lumen output and light distribution, vibration and shock, dust and humidity, heat and cold exposure, thermal cycling, thermal protection, electro-magnetic compatibility, full functionality, abnormal conditions, chemical resistance, and usability. Our products are valued for their even light distribution and high quality.

XTR



THE UNBREAKABLE MASTER

We aim for perfection. This time, it meant creating something unbreakable. May we introduce our XTR series; premium lights with an outstanding lifespan and light output up to 7200 lumens. The work lights in the XTR series come equipped with our revolutionary QUAKE dampening system (QD) designed to withstand the harshest conditions. With a strength capacity of 20 Grms, the XTR takes protection against shock and vibration to the next level.

PRO



THE HEAVY-DUTY CHAMPION

We give you options. For the products in the PRO series we offer a wide range of light patterns and possibilities for customization. The work lights in our PRO series are equipped with die-cast brackets and a dampening system with a strength capacity of up to 15.3 Grms. With a light output of up to 4400 lumens, the upmarket products in our PRO series are tough to beat.

GO SERIES



THE STEP-IT-UP SERIES

We believe in simplicity. The GO series is aimed at those customers who are completely new to our products or would like to enhance their lighting standard from halogen to LED. In this series, we designed a variety of standard models with a long lifespan and low maintenance. Easy to use, the work lights in the GO series have a light output of between 1000 and 3000 lumens, and a dampening strength capacity of 8 Grms.

KL SERIES



THE AFFORDABLE ONE

We create sensible solutions. The work lights in our KL series are an excellent choice when you're looking for a cost-effective alternative for your heavy-duty equipment. This go-to product line is developed with both new and existing customers in mind, optimizing basic design and low-maintenance. The KL lights withstand vibration up to 8 Grms and their light output ranges from 300 to 2150 lumens.

MIRAGE

MEASUREMENTS

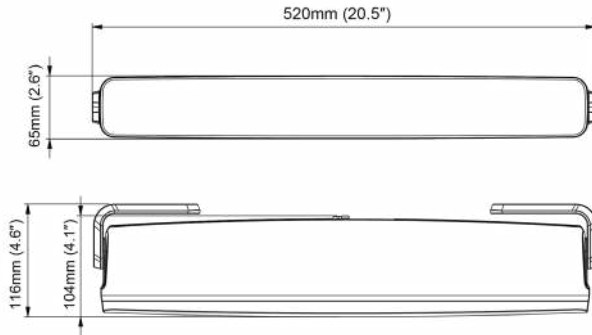

THE MARVELOUS

The Mirage is our very first LED light bar for on- and off-road vehicles, combining heavy-duty standards with an automotive look. This clean-cut auxiliary light ticks all the boxes in terms of durability and design, with smooth edges all around to prevent ice and dirt from accumulating, and a hard-coated polycarbonate lens for superb impact resistance. The light beam is designed wider than average for the best possible vision. An even light distribution combined with the warm color temperature of 4500K gives you a clear advantage – a flicker- and streak-free illumination in visually demanding circumstances such as rain, dust, fog, or snow. Possible to mount both high and low – simply flip it to suit your application.



NEW!



FEATURED PRODUCT



TECHNICAL SPECIFICATIONS	MIRAGE
Operational Lumens Output:	6200lm (Boost:7100lm)
Color Temperature:	4500K
Nominal / Input Voltage DC:	12–24V / 9–32V
Power Consumption:	84W (Boost:118W)
Nominal Current:	3.3A@24V / 7A@12V, (Boost: 4.4A@24V / 9.8A@12V)
Mount:	2 pcs M8 screw
Connector:	Built-in Deutsch DT-3 (3-pin)
EMC:	CISPR 25 Class 5, ISO 13766, ISO 14982, ISO 7637-2
Approvals:	ECE
Electronics:	Isolated
Shock:	60G
IP Rating:	IP68, IP6K9K
Weight:	2.8kg
Operating Temperatures:	-40°C... +85°C (Overheat protected)
Reference Number	50

LIGHT PATTERNS

Mirage, 6200lm
Standard

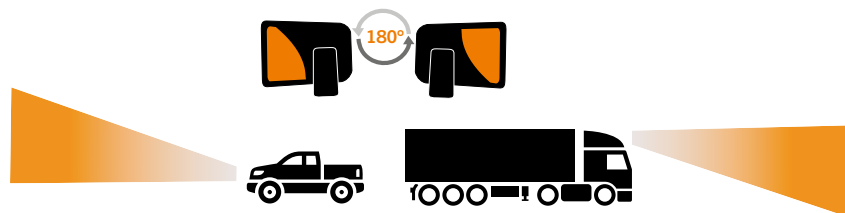
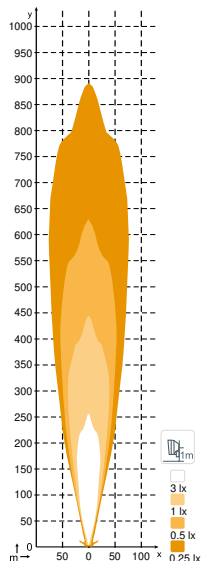

FOR CARS AND TRUCKS - simply flip to suit your applicaton



 **NORDICLIGHTS**

2.0L 4MATIC

4MATIC

SCORPIUS

MEASUREMENTS

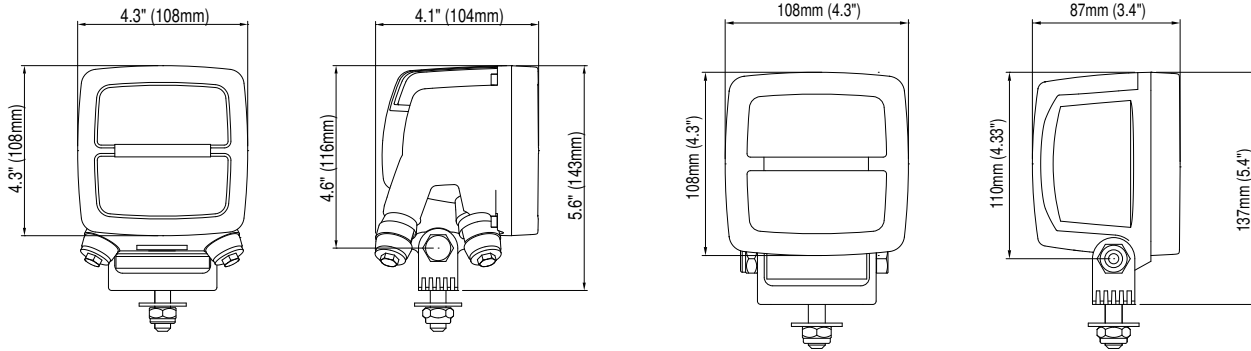

IN A LEAGUE OF ITS OWN

The Scorpius product family has a square form factor, and an output ranging between 2000 and 7200 lumens. These LED work lights have an asymmetric wide flood light pattern option particularly suitable for large, open spaces. The Scorpius product series is the most popular in our collection and sees use in many industries, including mining, construction, forestry, trucking, emergency response, agriculture, and material handling. If you're looking for products for the harshest conditions, choose the XTR versions equipped with Nordic Lights' **QUAKE dampening (QD)** system





MEASUREMENTS

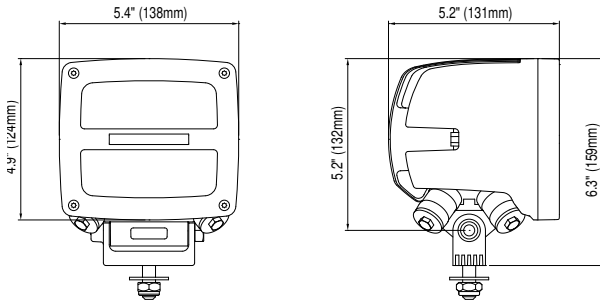

TECHNICAL SPECIFICATIONS	SCORPIUS LED N4601 QD
Theoretical / Operational Lumens:	11500lm / 7200lm
Color Temperature:	5700K
Nominal / Input Voltage DC:	24V / 18-32V
Power Consumption:	85W
Nominal Current:	3.5A@24V
Mount:	Single Bolt M10
Connector:	Built-in Deutsch DT-2 (2-pin)
EMC:	CISPR 25 Class 3, ISO 13766, ISO 14982, ISO 7637-2
Shock:	60G
Vibration:	15.3Grms 24-2000Hz, 4.65Grms 12-2000Hz
IP Rating:	IP68, IP6K9K, SAE J1455
Weight:	2.5kg
Operating Temperatures:	-40°C... +85°C (Overheat protected)

LIGHT PATTERNS

N4601 QD 7200lm High Beam

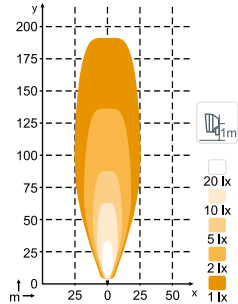

N4601 QD 7200lm Low Beam

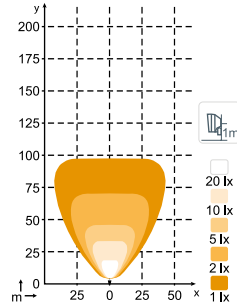

N4601 QD 7200lm Wide Flood

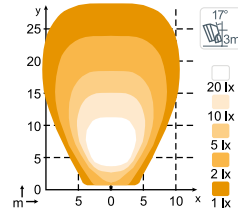

N4601 QD 7200lm Flood

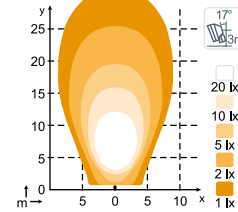



LED SERIES XTR/PRO



TECHNICAL SPECIFICATIONS	SCORPIUS LED N4401 QD	SCORPIUS LED N4402
Theoretical / Operational Lumens:	6700 lm / 4200lm	6700 lm / 4200lm
Color Temperature:	5700K	5700K
Nominal / Input Voltage DC:	12–24V / 9–32V	12–24V / 9–32V
Power Consumption:	50W	50W
Nominal Current:	2.1A@24V / 4.2A@12V	2.1A@24V / 4.2A@12V
Mount:	Single Bolt M10	Single Bolt M10
Connector:	Built-in Deutsch DT-2 (2-pin)	Built-in Deutsch DT-2 (2-pin)
EMC:	CISPR 25 Class 5, ISO 13766, ISO 14982, ISO 7637-2	CISPR 25 Class 5, ISO 13766, ISO 14982, ISO 7637-2
Shock:	60G	60G
Vibration:	20Grms 24–2000Hz, 4.65Grms 12–2000Hz	15.3Grms 24–2000Hz
IP Rating:	IP68, IP6K9K, SAE J1455	IP68, IP6K9K, SAE J1455
Weight:	1.6kg	1.1kg
Operating Temperatures:	-40°C... +85°C (Overheat protected)	-40°C... +85°C (Overheat protected)

LIGHT PATTERNS

N4401 QD, N4402 4200lm
High Beam

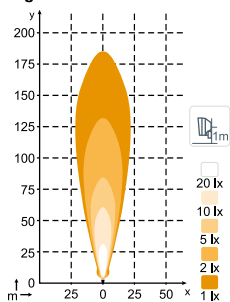

N4401 QD, N4402 4200lm
Low Beam

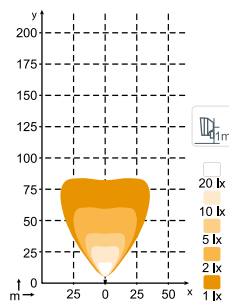

N4401 QD, N4402 4200lm
Wide Flood

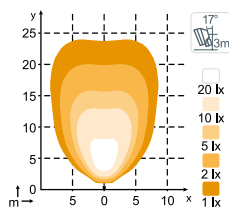

N4401 QD, N4402 4200lm
Flood

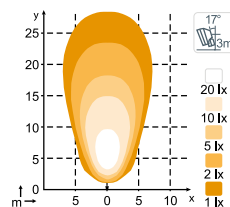

N4401 QD, N4402 3360lm
Diffused

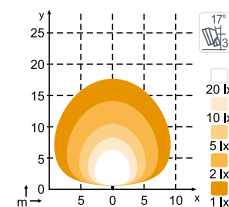



TECHNICAL SPECIFICATIONS	SCORPIUS LED N4403 QD	SCORPIUS LED N4404
Theoretical / Operational Lumens:	5000lm / 3200lm	5000lm / 3200lm
Color Temperature:	5700K	5700K
Nominal / Input Voltage DC:	12–24V / 9–32V	12–24V / 9–32V
Power Consumption:	35W	35W
Nominal Current:	1.45A@24V / 2.9A@12V	1.45A@24V / 2.9A@12V
Mount:	Single Bolt M10	Single Bolt M10
Connector:	Built-in Deutsch DT-2 (2-pin)	Built-in Deutsch DT-2 (2-pin)
EMC:	CISPR 25 Class 5, ISO 13766, ISO 14982, ISO 7637-2	CISPR 25 Class 5, ISO 13766, ISO 14982, ISO 7637-2
Shock:	60G	60G
Vibration:	20Grms 24–2000Hz, 4.65Grms 12–2000Hz	15.3Grms 24–2000Hz
IP Rating:	IP68, IP6K9K, SAE J1455	IP68, IP6K9K, SAE J1455
Weight:	1.6kg	1.1kg
Operating Temperatures:	-40°C... +85°C (Overheat protected)	-40°C... +85°C (Overheat protected)

LIGHT PATTERNS

**N4403 QD, N4404, 3200lm
High Beam**

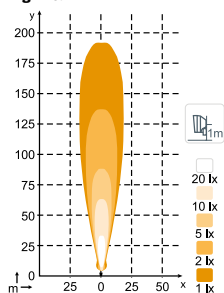

**N4403 QD, N4404, 3200lm
Low Beam**

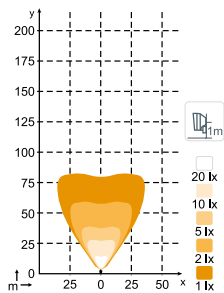

**N4403 QD, N4404, 3200lm
Wide Flood**

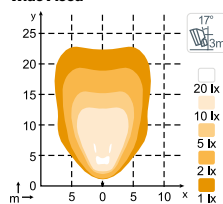

**N4403 QD, N4404, 3200lm
Flood**

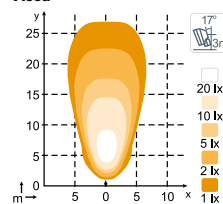

**N4403 QD, N4404, 2500lm
Diffused**

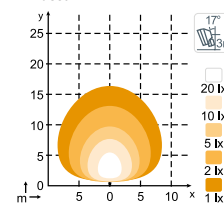





TECHNICAL SPECIFICATIONS	SCORPIUS LED N4405 QD	SCORPIUS LED N4406
Theoretical / Operational Lumens:	3700lm / 2300lm	3700lm / 2300lm
Color Temperature:	5700K	5700K
Nominal / Input Voltage DC:	12–24V / 9–32V	12–24V / 9–32V
Power Consumption:	22W	22W
Nominal Current:	0.9A@24V / 1.8A@12V	0.9A@24V / 1.8A@12V
Mount:	Single Bolt M10	Single Bolt M10
Connector:	Built-in Deutsch DT-2 (2-pin)	Built-in Deutsch DT-2 (2-pin)
EMC:	CISPR 25 Class 5, ISO 13766, ISO 14982, ISO 7637-2	CISPR 25 Class 5, ISO 13766, ISO 14982, ISO 7637-2
Shock:	60G	60G
Vibration:	20Grms 24–2000Hz, 4.65Grms 12–2000Hz	15.3Grms 24–2000Hz
IP Rating:	IP68, IP6K9K, SAE J1455	IP68, IP6K9K, SAE J1455
Weight:	1.6kg	1.1kg
Operating Temperatures:	-40°C... +85°C (Overheat protected)	-40°C... +85°C (Overheat protected)

LIGHT PATTERNS

**N4405 QD, N4406, 2200lm
High Beam**

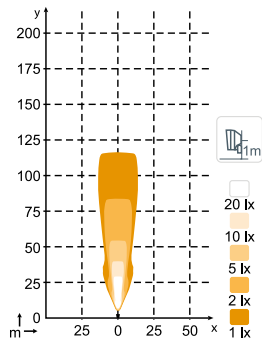

**N4405 QD, N4406, 2200lm
Low Beam**

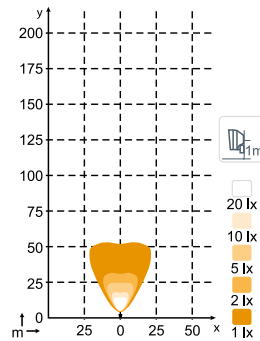

**N4405 QD, N4406, 2300lm
Wide Flood**

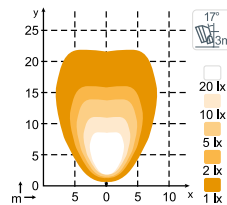

**N4405 QD, N4406, 2200lm
Flood**

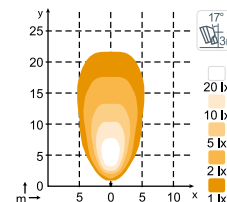

**N4405 QD, N4406, 1750lm
Diffused**

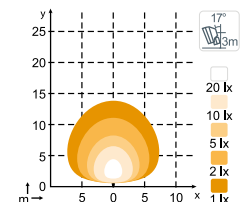

LED SERIES XTR/PRO



TECHNICAL SPECIFICATIONS	SCORPIUS LED N4407 QD	SCORPIUS LED N4408
Theoretical / Operational Lumens:	3700 lm / 2300lm	3700lm / 2300lm
Color Temperature:	5700K	5700K
Nominal / Input Voltage DC:	12–24V / 9–32V	12–24V / 9–32V
Power Consumption:	40W	40W
Nominal Current:	1.7A@24V / 3.4A@12V	1.7A@24V / 3.4A@12V
Mount:	Single Bolt M10	Single Bolt M10
Connector:	Built-in Deutsch DT-2 (2-pin)	Built-in Deutsch DT-2 (2-pin)
EMC:	CISPR 25 Class 3, ISO 13766, ISO 14982, ISO 7637-2	CISPR 25 Class 3, ISO 13766, ISO 14982, ISO 7637-2
Shock:	60G	60G
Vibration:	20Grms 24–2000Hz, 4.65Grms 12–2000Hz	15.3Grms 24–2000Hz
IP Rating:	IP68, IP6K9K, SAE J1455	IP68, IP6K9K, SAE J1455
Weight:	1.6kg	1.1kg
Operating Temperatures:	-40°C... +85°C (Overheat protected)	-40°C... +85°C (Overheat protected)

LIGHT PATTERNS

N4407 QD, N4408 2300lm
Pencil Beam

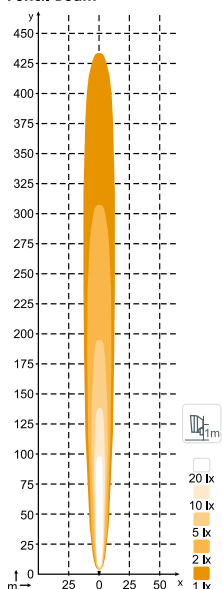

N4407 QD, N4408 2300lm
High Beam

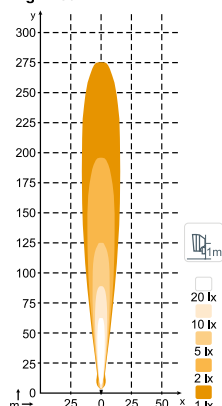

N4407 QD, N4408, 2300lm
Low Beam

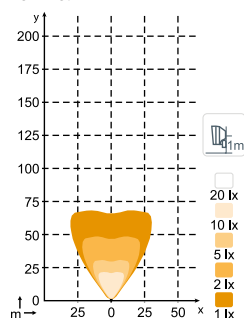



TECHNICAL SPECIFICATIONS	SCORPIUS LED N4409 QD	SCORPIUS LED N4410
Theoretical / Operational Lumens:	3700lm / 2300lm	3700lm / 2300lm
Color Temperature:	5700K	5700K
Nominal / Input Voltage DC:	12V, 24V / 9–16V, 18–32V (Dimmable)	12V, 24V / 9–16V, 18–32V (Dimmable)
Power Consumption:	40W	40W
Nominal Current:	1.7A@24V / 3.4A@12V	1.7A@24V / 3.4A@12V
Mount:	Single Bolt M10	Single Bolt M10
Connector:	Built-in Deutsch DT-2 (2-pin)	Built-in Deutsch DT-2 (2-pin)
EMC:	CISPR 25 Class 5, ISO 13766, ISO 14982, ISO 7637-2	CISPR 25 Class 5, ISO 13766, ISO 14982, ISO 7637-2
Electronics:	Isolated	Isolated
Shock:	60G	60G
Vibration:	20Grms 24–2000Hz, 4.65Grms 12–2000Hz	15.3Grms 24–2000Hz
IP Rating:	IP68, IP6K9K, SAE J1455	IP68, IP6K9K, SAE J1455
Weight:	1.6kg	1.1kg
Operating Temperatures:	-40°C... +85°C (Overheat protected)	-40°C... +85°C (Overheat protected)

LIGHT PATTERNS

N4409 QD, N4410, 2300lm
High Beam

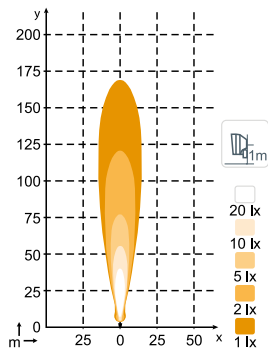

N4409 QD, N4410, 2300lm
Low Beam

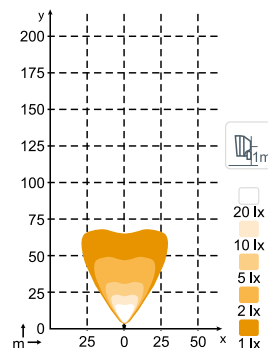

N4409 QD, N4410, 2300lm
Wide Flood

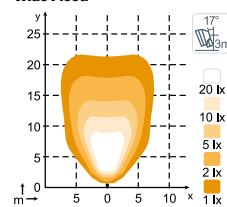

N4409 QD, N4410, 2300lm
Flood

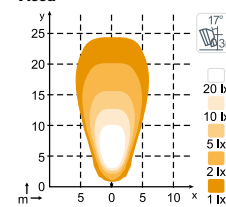

N4409 QD, N4410, 1800lm
Diffused

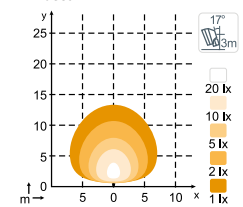



**NEW!**

TECHNICAL SPECIFICATIONS	SCORPIUS PRO 445	SCORPIUS PRO 430
Theoretical / Operational Lumens:	7000lm / 4400lm	4800lm / 3000lm
Color Temperature:	5000K	5000K
Nominal / Input Voltage DC:	12–24V / 9–32V	12V, 24V / 9–16V, 18–32V
Power Consumption:	50W	33W
Nominal Current:	2.1A@24V / 4.2A@12V	1.4A@24V / 2.8A@12V
Mount:	Single Bolt M10	Single Bolt M10
Connector:	Built-in Deutsch DT-2 (2-pin)	Built-in Deutsch DT-2 (2-pin)
EMC:	CISPR 25 Class 5, ISO 13766, ISO 14982, ISO 7637-2	CISPR 25 Class 5, ISO 13766, ISO 14982, ISO 7637-2
Electronics:	Isolated	Isolated
Shock:	60G	60G
Vibration:	15.3Grms 24–2000Hz	15.3Grms 24–2000Hz
IP Rating:	IP68, IP6K9K, SAE J1455	IP68, IP6K9K, SAE J1455
Weight:	1.1kg	1.1kg
Operating Temperatures:	-40°C... +85°C (Overheat protected)	-40°C... +85°C (Overheat protected)

LIGHT PATTERNS

Scorpius PRO 445, 4400lm
High Beam

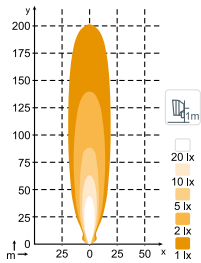

Scorpius PRO 445, 4400lm
Flood

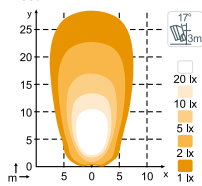

Scorpius PRO 445, 4400lm
Wide Flood (Symmetric)

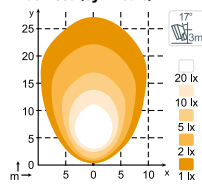

Scorpius PRO 430, 3000lm
High Beam

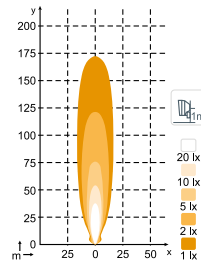

Scorpius PRO 430, 3000lm
Flood

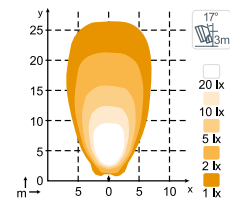

Scorpius PRO 430, 3000lm
Wide Flood (Symmetric)

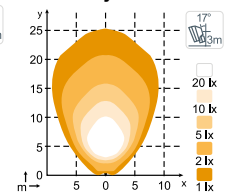

Scorpius PRO 445, 4400lm
Wide Flood (Asymmetric)

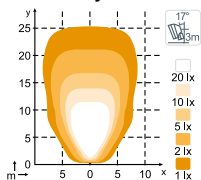

Scorpius PRO 430, 3000lm
Wide Flood (Asymmetric)

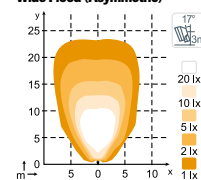



NEW!



TECHNICAL SPECIFICATIONS	SCORPIUS LED N4402 WARM	SCORPIUS 400 BLUE
Theoretical / Operational Lumens:	5700lm / 3600lm	Luminous intensity: 30000cd
Color Temperature:	2700K	Light Color: Blue, 475nm
Nominal / Input Voltage DC:	12–24V / 9–32V	12V, 24V / 9–16V, 18–32A
Power Consumption:	50W	42W
Nominal Current:	2.0A@24V / 3.9A@12V	2.1A@ 24V / 4.2A@12V
Mount:	Single Bolt M10	Single Bolt M10
Connector:	Built-in Deutsch DT-2 (2-pin)	Built-in Deutsch DT-2 (2-pin)
EMC:	CISPR 25 Class 5, ISO 13766, ISO 14982, ISO 7637-2	CISPR 25 Class 5, ISO 13766, ISO 14982, ISO 7637-2, EN 61000-4-2
Electronics:	Isolated	Isolated
Shock:	60G	60G
Vibration:	15.3Grms 24–2000Hz	15.3Grms 24–2000Hz
IP Rating:	IP68, IP6K9K, SAE J1455	IP68, IP6K9K
Weight:	1.1kg	1.1kg
Operating Temperatures:	-40°C... +85°C (Overheat protected)	-40°C... +85°C (Overheat protected)

LIGHT PATTERNS

N4402 WARM, 3600lm High Beam

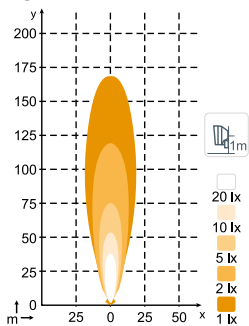

N4402 WARM, 3600lm Low Beam

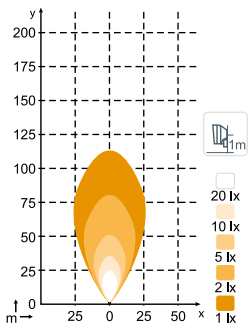

N4402 WARM, 3600lm Wide Flood

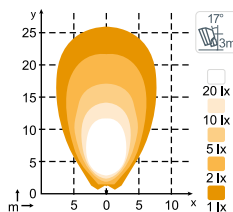

N4402 WARM, 3600lm Flood

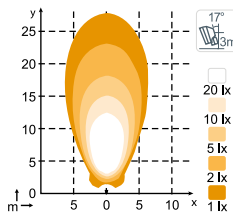

Scorpius 400 BLUE, 475nm Pencil Beam

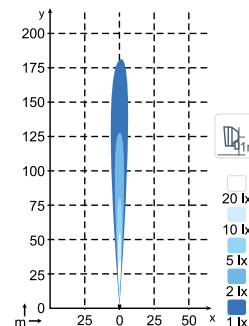



CANIS PRO 330

MEASUREMENTS

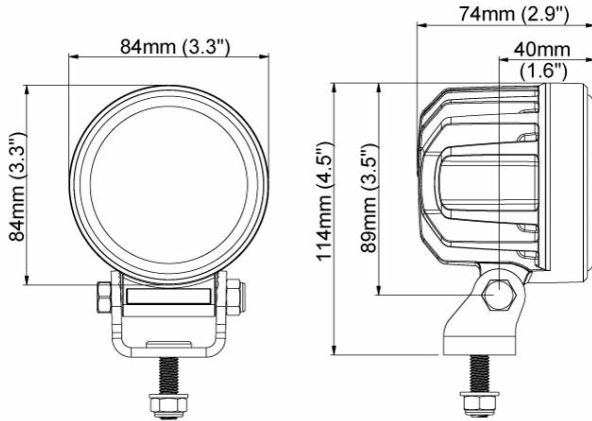

READY TO RUMBLE

Born out of a search for raw power in a small package, the highly efficient Canis PRO 330 offers lots of lumens in a compact size. Perfect for demanding industries such as mining, construction, forestry and agriculture, this glass-lensed work light easily fits into tight spaces and is available with three different light patterns, including a horizontally extended Wide Flood and a slightly softer-than-usual High Beam. The Canis PRO 330 withstands vibrations of up to 15.3 Grms at 24-2000Hz and delivers 3000 operational lumens.







TECHNICAL SPECIFICATIONS	CANIS PRO 330
Theoretical / Operational Lumens:	4800lm / 3000lm
Color Temperature:	5000K
Nominal / Input Voltage DC:	12–24V / 9–32V
Power Consumption:	28W
Nominal Current:	2.3A@12V / 1.15A@24V
Mount:	Single Bolt M8
Connector:	Built-in Deutsch DT-2 (2-pin)
EMC:	CISPR 25 Class 5
Electronics:	Isolated
Shock:	60G
Vibration:	15.3Grms 24–2000Hz
IP Rating:	IP68, IP6K9K
Weight:	0.65kg
Operating Temperatures:	-40°C... +85°C (Overheat protected)

LIGHT PATTERNS

**Canis PRO 330, 3000lm
High Beam**

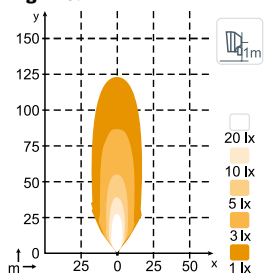

**Canis PRO 330, 3000lm
Flood**

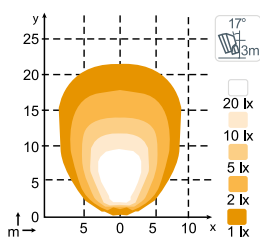

**Canis PRO 330, 3000lm
Wide Flood**

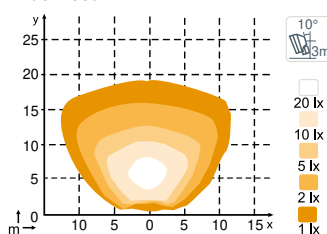



Phenom Optics Equipped

MEASUREMENTS

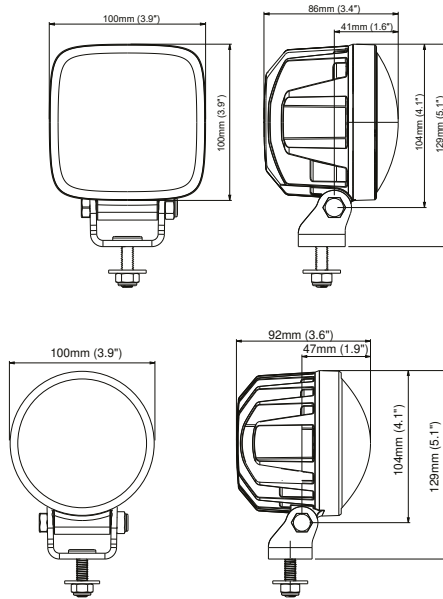

NO GLARE WITH PHENOM OPTICS

Blinding people with your work lights is a thing of the past with the Phenom Optics (pat. pending) equipped Canis and Scorpius PRO 415 PH. With these work lights you will have maximum safety and high visibility, with a glare-free zone and all light focused on the desired areas. Canis and Scorpius PRO 415 PH are compact and lightweight, ideal for vehicles in material handling and construction. Thanks to the clear cut-off line, they have an asymmetrical wide flood light pattern that doesn't reach eye-level but still illuminates the work area efficiently. They deliver an operational lumen output of 1500 lm and withstand vibrations of up to 8 Grms.







TECHNICAL SPECIFICATIONS	SCORPIUS PRO 415 PH	CANIS PRO 415 PH
Theoretical / Operational Lumens:	1950lm / 1500lm	1950lm / 1500lm
Color Temperature:	5000K	5000K
Nominal / Input Voltage DC:	12V, 24V / 9–16, 18–32V	12V, 24V / 9–16, 18–32V
Power Consumption:	28W	28W
Nominal Current:	1.2A@24V / 2.4A@12V	1.2A@24V / 2.4A@12V
Mount:	Single Bolt M8	Single Bolt M8
Connector:	Built-in Deutsch DT-2 (2-pin)	Built-in Deutsch DT-2 (2-pin)
EMC:	CISPR 25 Class 5, EN 14982-2, ISO 13766, EN 12895, ISO 11452-2, EN 13309, ISO 7637-2	CISPR 25 Class 5, EN 14982-2, ISO 13766, EN 12895, ISO 11452-2, EN 13309, ISO 7637-2
Electronics:	Isolated	Isolated
Shock:	60G	60G
Vibration:	8 Grms 24–2000Hz	8 Grms 24–2000Hz
Lens:	Glass	Glass
Body:	IP68, IP6K9K	IP68, IP6K9K
Weight:	0.6kg	0.6kg
Operating Temperatures:	-40°C... +85°C (Overheat protected)	-40°C... +85°C (Overheat protected)

LIGHT PATTERNS

Scorpius PRO 415 PH, 1500lm
Wide Flood

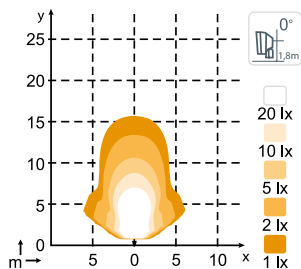

Canis PRO 415 PH, 1500lm
Wide Flood

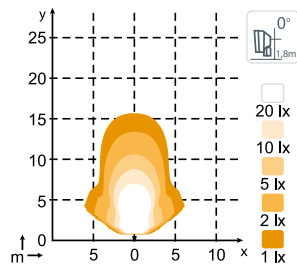

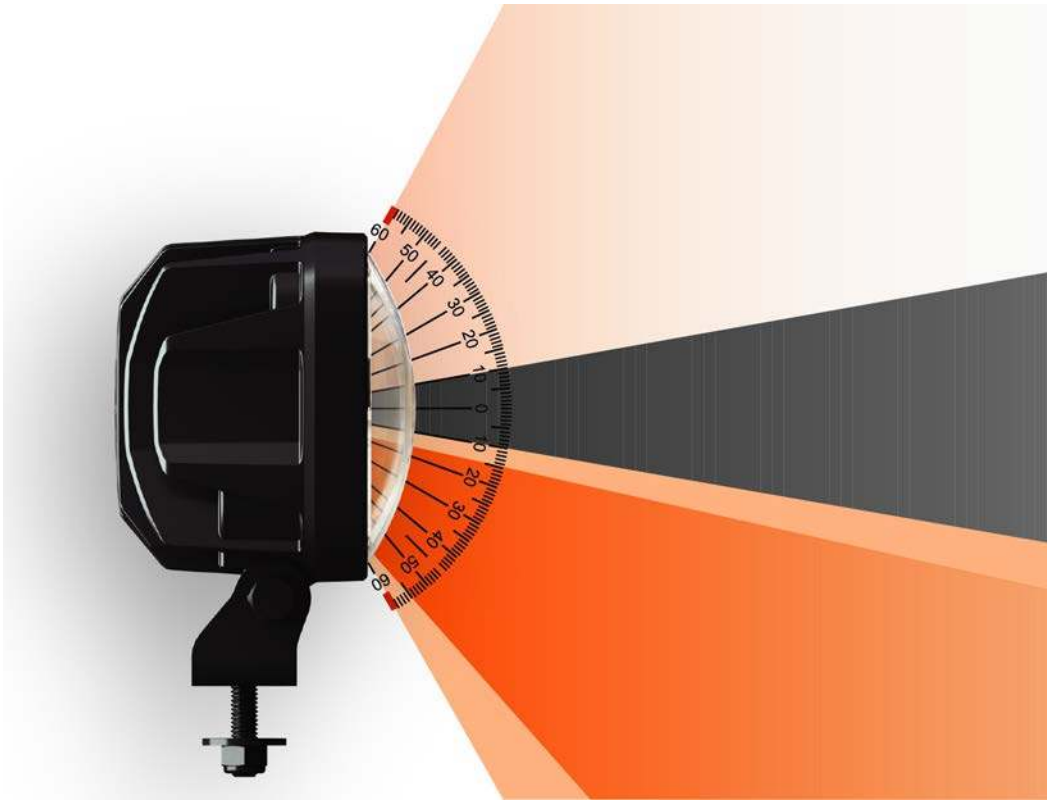

ACCENT LIGHTING

Soft illumination upwards as a guide light for successful lifting or other operations.

GLARE FREE ZONE

Will not blind people working near the vehicle.

TASK LIGHTING

Effectively illuminating the work area.

Maximum safety and high visibility with light focused on desired areas.

GO SERIES



SCORPIUS GO

Our entry-level Scorpius GO is easy to use. There are four light pattern options: flood, wide flood, high beam, and reverse. Useful in construction, forestry, agriculture, and material handling, the Scorpius product family has a square form factor and pedestal mounting. The light produces zero emissions (EMC CISPR 25 class 5) and its light output is up to 3000 lumens.



SCORPIUS GO 410

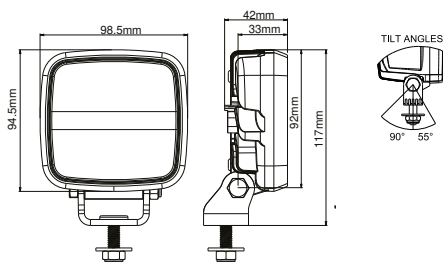

SCORPIUS GO 420

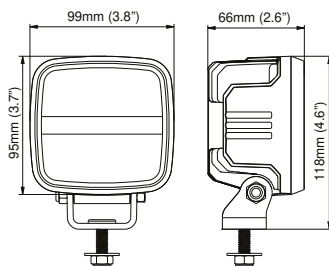

SCORPIUS GO 430

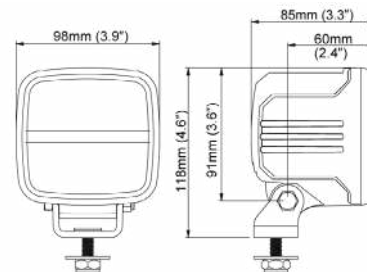

CANIS GO

Our entry-level Canis GO is as good as it gets. While it is lighter than the original, the operational lumen output is just as high. Best suited to construction, forestry, agriculture, and material handling, the Canis GO has a round form factor and pedestal mounting, it produces zero emissions (EMC CISPR 25 class 5) and its light output is up to 1800 lumens.

SATO GO

Our entry-level Sato GO is a quality solution offering effective illumination. There are two light pattern options: flood and wide flood. Best suited to construction, forestry, and agriculture, the Sato GO has an oval form factor and pedestal mounting. It produces zero emissions (EMC CISPR 25 class 5) and its light output is up to 2300 lumens.

CANIS GO 410

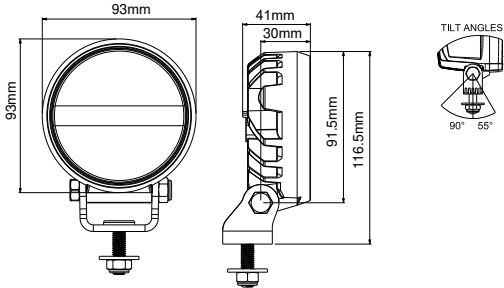

CANIS GO 420

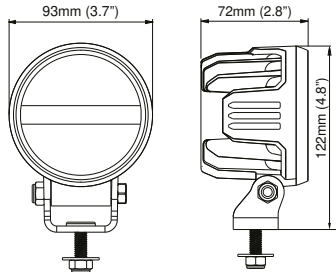

SATO GO 610 & 625

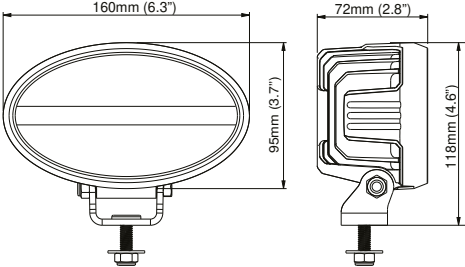



TECHNICAL SPECIFICATIONS	SCORPIUS GO 410	SCORPIUS GO 420
Theoretical / Operational Lumens:	1600lm / 1000lm	2800lm / 1800lm
Color Temperature:	5000K	5000K
Nominal / Input Voltage DC:	12V, 24V / 9–16V, 18–32V, 36V, 48V / 30–64V (Dimmable)	12V, 24V / 9–16V, 18–32V (Dimmable)
Power Consumption:	16W (12/24V), 18W (36/48V)	28W
Nominal Current:	0.38A@36V, 48V / 0.6A@24V / 1.05A@12V	1.0A@24V / 1.8A@12V
Mount:	Single Bolt M8	Single Bolt M8
Connector:	Built-in Deutsch DT-2 (2-pin)	Built-in Deutsch DT-2 (2-pin)
EMC:	CISPR 25 Class 5, EN12895, ISO 13766, ISO 14982, ISO 7637-2	CISPR 25 Class 5, EN12895, ISO 13766, ISO 14982, ISO 7637-2
Electronics:	Isolated	Isolated
Shock:	60G	60G
Vibration:	8Grms 24-2000Hz	8Grms 24–2000Hz
IP Rating:	IP68, IP6K9K	IP68, IP6K9K
Weight:	0.6kg	0.6kg
Operating Temperatures:	–40°C... +85°C (Overheat protected)	–40°C... +85°C (Overheat protected)

LIGHT PATTERNS

Scorpius GO 410, 1000lm Wide Flood

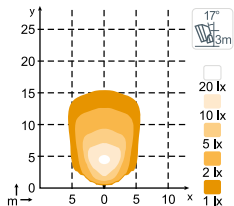

Scorpius GO 410, 1000lm Flood

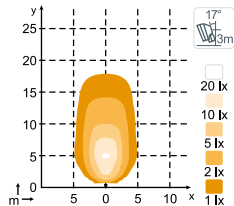

Scorpius GO 410 R, 1000lm Reverse (ECE R23)

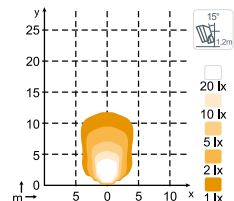

Scorpius GO 420, 1800lm High Beam

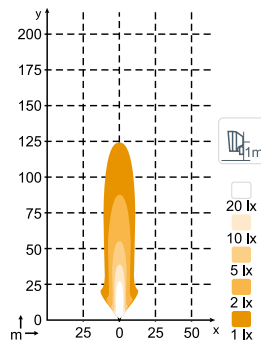

Scorpius GO 420, 1800lm Wide Flood

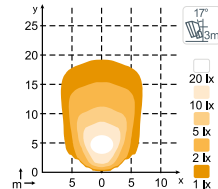

Scorpius GO 420, 1800lm Flood

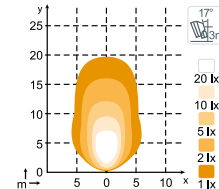



TECHNICAL SPECIFICATIONS	SCORPIUS GO 430
Theoretical / Operational Lumens:	4800lm / 3000lm
Color Temperature:	5000K
Nominal / Input Voltage DC:	12V, 24V / 9–16V, 18–32V (Dimmable)
Power Consumption:	44W
Nominal Current:	1.5A@ 24V / 2.8A@12V
Mount:	Single Bolt M8
Connector:	Built-in Deutsch DT-2 (2-pin)
EMC:	CISPR 25 Class 5, EN12895, ISO 13766, ISO 14982, ISO 7637-2
Electronics:	Isolated
Shock:	60G
Vibration:	8Grms 24–2000Hz
IP Rating:	IP68, IP6K9K
Weight:	0.79kg
Operating Temperatures:	-40°C... +85°C (Overheat protected)

LIGHT PATTERNS

Scorpius GO 430, 3000lm High Beam

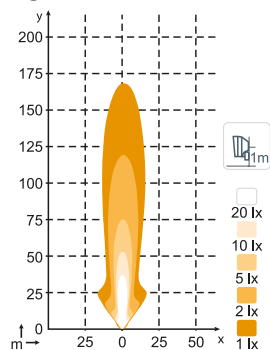

Scorpius GO 430, 3000lm Wide Flood

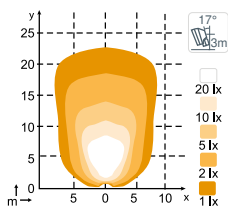

Scorpius GO 430, 3000lm Flood

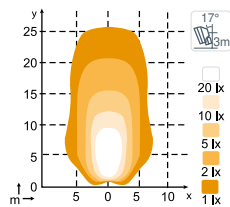



TECHNICAL SPECIFICATIONS	CANIS GO 410	CANIS GO 420
Theoretical / Operational Lumens:	1600lm / 1000lm	2800lm / 1800lm
Color Temperature:	5000K	5000K
Nominal / Input Voltage DC:	12V, 24V / 9–16V, 18–32V, 36V, 48V / 30–64V (Dimmable)	12V, 24V / 9–16V, 18–32V (Dimmable)
Power Consumption:	16W (12/24V), 18W (36/48V)	28W
Nominal Current:	0.38A@36V, 48V / 0.6A@24V / 1.05A@12V	1.0A@24V / 1.8A@12V
Mount:	Single Bolt M8	Single Bolt M8
Connector:	Built-in Deutsch DT-2 (2-pin)	Built-in Deutsch DT-2 (2-pin)
EMC:	CISPR 25 Class 5, EN12895, ISO 13766, ISO 14982, ISO 7637-2	CISPR 25 Class 5, EN12895, ISO 13766, ISO 14982, ISO 7637-2
Electronics:	Isolated	Isolated
Shock:	60G	60G
Vibration:	8Grms 24–2000Hz	8Grms 24–2000Hz
IP Rating:	IP68, IP6K9K	IP68, IP6K9K
Weight:	0.5kg	0.5kg
Operating Temperatures:	–40°C... +85°C (Overheat protected)	–40°C... +85°C (Overheat protected)

LIGHT PATTERNS

**Canis GO 410, 1000lm
Wide Flood**

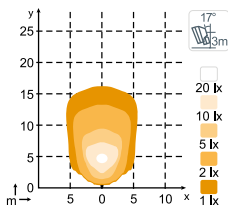

**Canis GO 410, 1000lm
Flood**

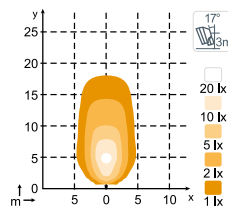

**Canis GO 420, 1800lm
High Beam**

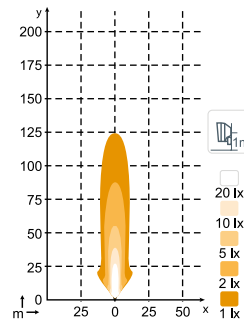

**Canis GO 420, 1800lm
Wide Flood**

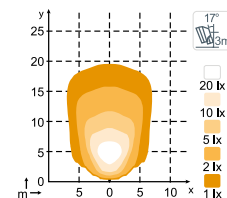

**Canis GO 420, 1800lm
Flood**

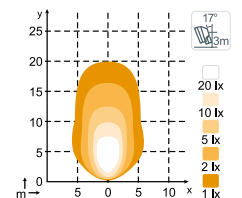

**Canis GO 410 R, 1000lm
Reverse (ECE R23)**

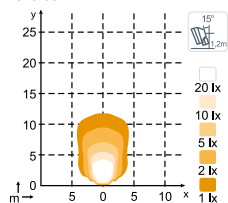





TECHNICAL SPECIFICATIONS	SATO GO 610	SATO GO 625
Theoretical / Operational Lumens:	1600lm / 1000lm	3600lm / 2300lm
Color Temperature:	5000K	5000K
Nominal / Input Voltage DC:	12V, 24V / 9–16V, 18–32V (Dimmable)	12V, 24V / 9–16V, 18–32V (Dimmable)
Power Consumption:	16W	39W
Nominal Current:	0.6A@24V / 1.05A@12V	1.4A@24V / 2.5A@12V
Mount:	Single Bolt M8	Single Bolt M8
Connector:	Built-in Deutsch DT-2 (2-pin)	Built-in Deutsch DT-2 (2-pin)
EMC:	CISPR 25 Class 5, EN12895, ISO 13766, ISO 14982, ISO 7637-2	CISPR 25 Class 5, EN12895, ISO 13766, ISO 14982, ISO 7637-2
Electronics:	Isolated	Isolated
Shock:	60G	60G
Vibration:	8Grms 24–2000Hz	8Grms 24–2000Hz
IP Rating:	IP68, IP6K9K	IP68, IP6K9K
Weight:	0.8kg	0.8kg
Operating Temperatures:	–40°C... +85°C (Overheat protected)	–40°C... +85°C (Overheat protected)

LIGHT PATTERNS

**Sato GO 610, 1000lm
Wide Flood**

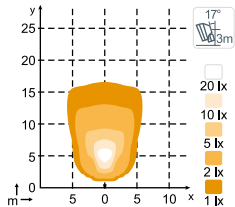

**Sato GO 610, 1000lm
Flood**

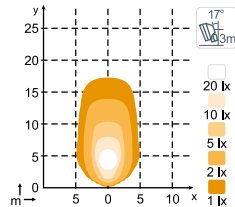

**Sato GO 625, 2300lm
Wide Flood**

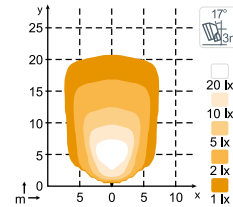

**Sato GO 625, 2300lm
Flood**

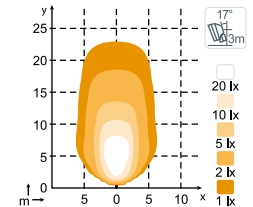



KL SERIES

MEASUREMENTS

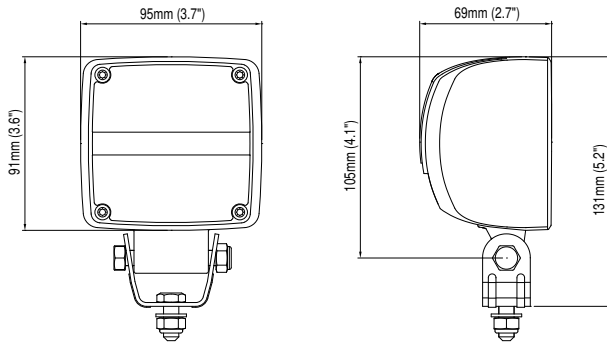

THE AFFORDABLE ONE

The KL work lights are an excellent choice when you're in need of an upgrade, whether replacing halogen work lights with LEDs or looking for a cost-effective alternative for your heavy-duty equipment. This go-to product line is developed with both new and existing customers in mind, optimizing basic design and low-maintenance. This series offers lights with bracket mounting and with surface mounting on vehicle bodies. Light output in the series ranges from 300 to 2150 lumens.







TECHNICAL SPECIFICATIONS	KL1001 LED	KL1002 LED
Theoretical / Operational Lumens:	1600lm / 1000lm	2400lm / 1500lm
Color Temperature:	5700K	5700K
Nominal / Input Voltage DC:	12V, 24V / 9–16V, 18–32V (Dimmable)	12V, 24V / 9–16V, 18–32V (Dimmable)
Power Consumption:	24W	24W
Nominal Current:	1.0A@24V / 2.0A@12V	1.0A@24V / 2.0A@12V
Mount:	Single Bolt M8	Single Bolt M8
Connector:	Fly Leads, Pigtail Deutsch 2-pin	Fly Leads, Pigtail Deutsch 2-pin
EMC:	CISPR 25 Class 5, EN 12895, ISO 13766, ISO 14982, ISO 7637-2	CISPR 25 Class 5, EN 12895, ISO 13766, ISO 14982, ISO 7637-2
Electronics:	Isolated	Isolated
Shock:	60G	60G
Vibration:	N/A	N/A
IP Rating:	IP68, IP6K9K, SAE J1455	IP68, IP6K9K, SAE J1455
Weight:	0.7kg	0.7kg
Operating Temperatures:	-40°C... +85°C (Overheat protected)	-40°C... +85°C (Overheat protected)

LIGHT PATTERNS

KL1001 1000lm Flood

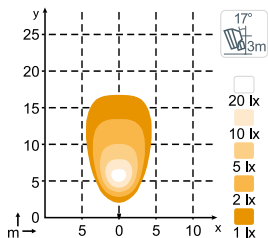

KL1001 800lm Diffused

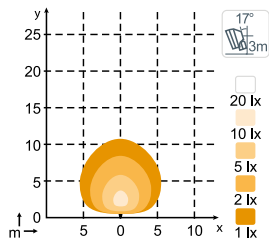

KL1002 1500lm Flood

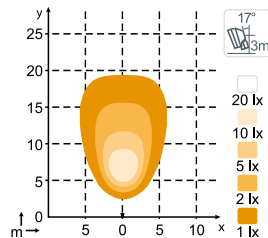

KL1002 1200lm Diffused

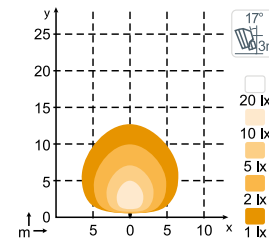

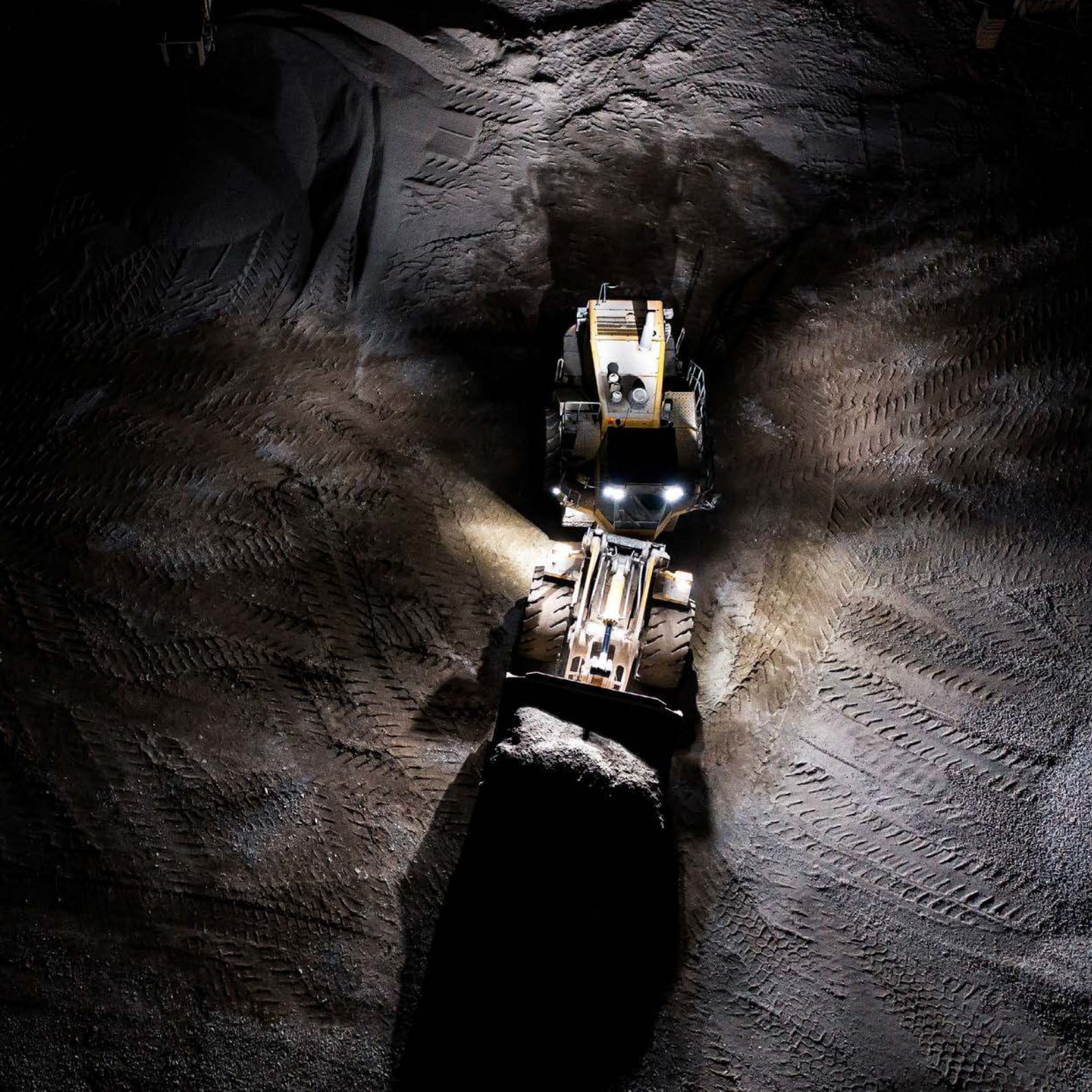



TECHNICAL SPECIFICATIONS	KL1401 LED	KL1501 LED
Theoretical / Operational Lumens:	3200lm / 2150lm	500lm / 300lm
Color Temperature:	5700K	5700K
Nominal / Input Voltage DC:	12–24V / 9–16V, 18–32V (Dimmable)	12–24V / 9–16V, 18–32V (Dimmable)
Power Consumption:	42W	10W
Nominal Current:	1.7A@24V / 3.5A@12V	0.4A@24V / 0.8A@12V
Mount:	Single Bolt M10	Single Bolt M8
Connector:	Built-in Deutsch DT-2 (2-pin)	Built-in Deutsch DT-2 (2-pin)
EMC:	CISPR 25 Class 5, EN12895, ISO 13766, ISO 14982, ISO 7637-2	CISPR 25 Class 5, EN12895, ISO 13766, ISO 14982, ISO 7637-2
Electronics:	Isolated	Isolated
Shock:	60G	60G
Vibration:	8Grms 24–2000Hz	8Grms 24–2000Hz
IP Rating:	IP68, IP6K9K, SAE J1455	IP68, IP6K9K, SAE J1455
Weight:	0.9kg	0.2kg
Operating Temperatures:	-40°C... +85°C (Overheat protected)	-40°C... +85°C (Overheat protected)

LIGHT PATTERNS

**KL1401, 2150lm
Wide Flood**

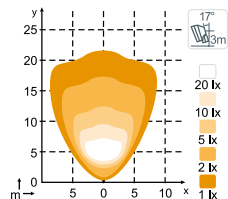

**KL1401, 2150lm
Flood**

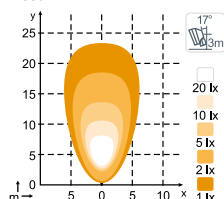

**KL1501 300lm
Flood**

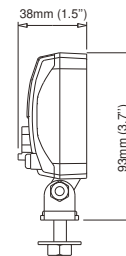
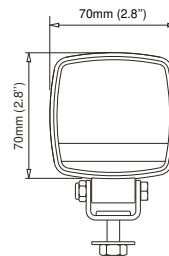
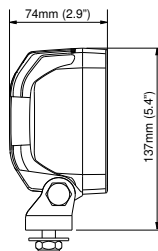
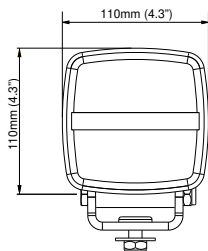
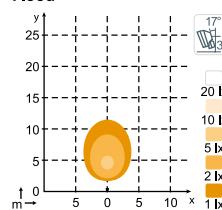



TECHNICAL SPECIFICATIONS	KL2001 LED
Theoretical / Operational Lumens:	1900lm / 1200lm
Color Temperature:	5700K
Nominal / Input Voltage DC:	12–24V / 9–16V, 18–32V (Dimmable)
Power Consumption:	20W
Nominal Current:	0.8A@24V / 1.7A@12V
Mount:	Single Bolt M10
Connector:	Built-in Deutsch DT-2 (2-pin)
EMC:	CISPR 25 Class 5, EN12895, ISO 13766, ISO 14982, ISO 7637-2
Electronics:	Isolated
Shock:	60G
Vibration:	8Grms 24–2000Hz
IP Rating:	IP68, IP6K9K, SAE J1455
Weight:	0.5kg
Operating Temperatures:	-40°C... +85°C (Overheat protected)

LIGHT PATTERNS

**KL2001 1200lm
Wide Flood**

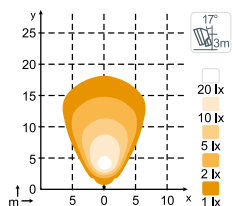

**KL2001 1200lm
Flood**

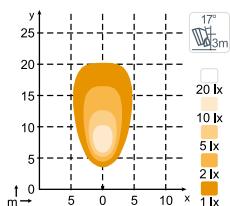

**KL2001 900lm
Diffused**

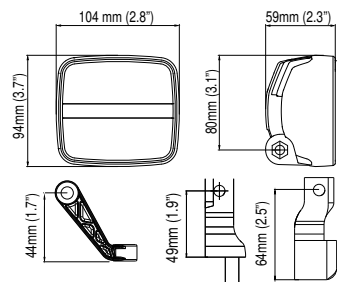
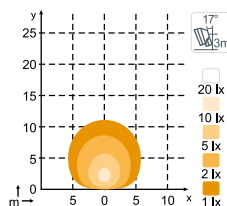

KL FLUSH MOUNT



TECHNICAL SPECIFICATIONS	KL1302 LED F7°
Theoretical / Operational Lumens:	2400lm / 1500lm
Color Temperature:	5700K
Nominal / Input Voltage DC:	12–24V / 9–16V, 18–32V (Dimmable)
Power Consumption:	24W
Nominal Current:	1.0A@24V / 2.0A@12V
Mount:	Integrated
Connector:	Fly Leads Pigtail Deutsch 2-pin
EMC:	CISPR 25 Class 5, EN 12895, ISO 13766, ISO 14982, ISO 7637-2
Electronics:	Isolated
Shock:	60G
Vibration:	8Grms 24–2000Hz
IP Rating:	IP68, IP6K9K, SAE J1455
Weight:	0.45kg
Operating Temperatures:	-40°C... +85°C (Overheat protected)

LIGHT PATTERNS & DRAWINGS

**KL1302, KL1304 1500lm
Flood**

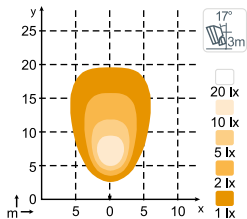

**KL1302, KL1304 1200lm
Diffused**

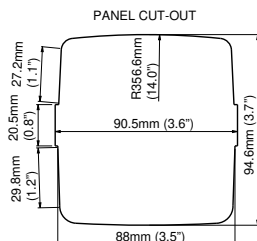
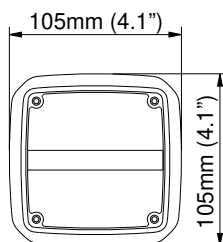
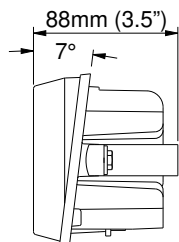
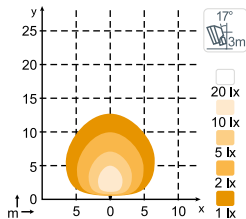



TECHNICAL SPECIFICATIONS	KL1304 LED F0°	KL1305 LED F7° SNAP-IN
Theoretical / Operational Lumens:	2400lm / 1500lm	1300lm / 800lm
Color Temperature:	5700K	5700K
Nominal / Input Voltage DC:	12–24V / 9–16V, 18–32V (Dimmable)	12–24V / 9–16V, 18–32V (Dimmable)
Power Consumption:	24W	20W
Nominal Current:	1.0A@24V / 2.0A@12V	0.8A@24V / 1.7A@12V
Mount:	Integrated	Integrated
Connector:	Fly Leads Pigtail Deutsch 2-pin	Built-in Deutsch DT-2 (2-pin)
EMC:	CISPR 25 Class 5, EN 12895, ISO 13766, ISO 14982, ISO 7637-2	CISPR 25 Class 5, EN12895, ISO 13766, ISO 14982, ISO 7637-2
Electronics:	Isolated	Isolated
Shock:	60G	60G
Vibration:	8Grms 24–2000Hz	15.3Grms 24–2000Hz
IP Rating:	IP68, IP6K9K, SAE J1455	IP68, IP6K9K, SAE J1455
Weight:	0.45kg	0.5kg
Operating Temperatures:	-40°C... +85°C (Overheat protected)	-40°C... +85°C (Overheat protected)

LIGHT PATTERNS & DRAWINGS

KL1302, KL1304 1500lm Flood

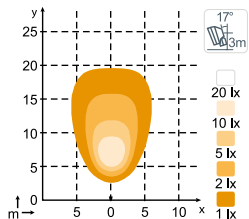

KL1302, KL1304 1200lm Diffused

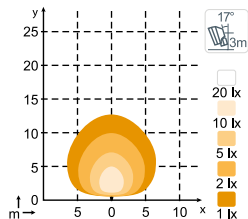

KL1305 800lm Flood

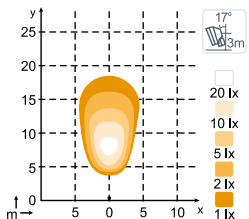

KL1305 800lm Wide Flood

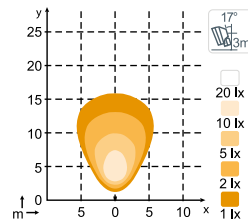

KL1305 700lm Diffused

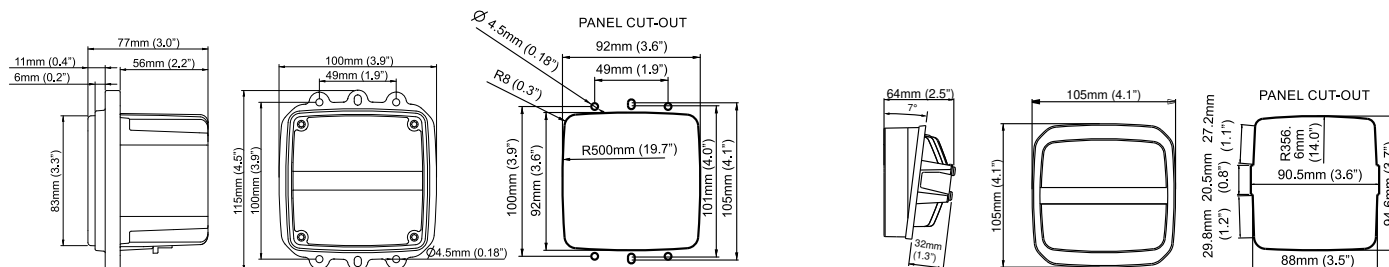
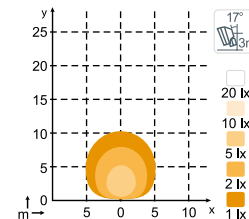

SATO 725

MEASUREMENTS

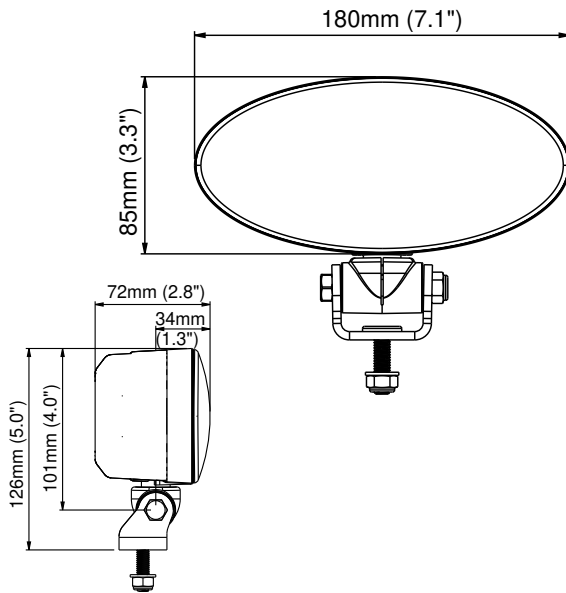

READY FOR PRIME TIME

With a light pattern optimized for tractors and other agricultural vehicles, and a tempered glass lens for excellent chemical resistance, the Sato 725 is ready to hit the fields. Thanks to the perfect color rendering that allows you to see clearly and easily distinguish different materials, this work light will make your job easier and more efficient. Unwanted electrical interference will not compromise the operation of your vehicle as this light is ECE R10-approved. The hassle-free Sato 725 comes with a swivel bracket for easy adjustment of the light beam and is a plug-and-play replacement for other oval work lights on the market. An excellent fit for agriculture, the Sato 725 withstands vibration of up to 8 Grms at 5-2000Hz and delivers 2200 operational lumens.



TECHNICAL SPECIFICATIONS	SATO 725
Theoretical / Operational Lumens:	3500lm / 2200lm
Color Temperature:	5000K
Nominal / Input Voltage DC:	12V, 24V / 9-16V, 18-32V (Dimmable)
Power Consumption:	32W
Nominal Current:	1.4A@24V / 2.5A@12V
Mount:	Single Bolt M8
Connector:	Built-in Deutsch DT-2 (2-pin)
EMC:	CISPR 25 Class 5, EN 12895 , ISO 13766, ISO 14982, ISO 7637-2, ECE R10
Electronics:	Isolated
Vibration:	8Grms 5–2000Hz
IP Rating:	IP68, IP6K9K
Weight:	0.8kg
Operating Temperatures:	-40 to +85 °C (Overheat protected)



LIGHT PATTERNS

Sato 725, 2200lm
Flood

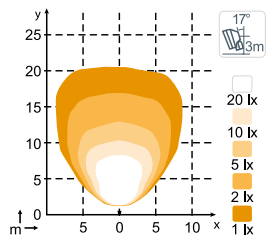

GEMINI

MEASUREMENTS

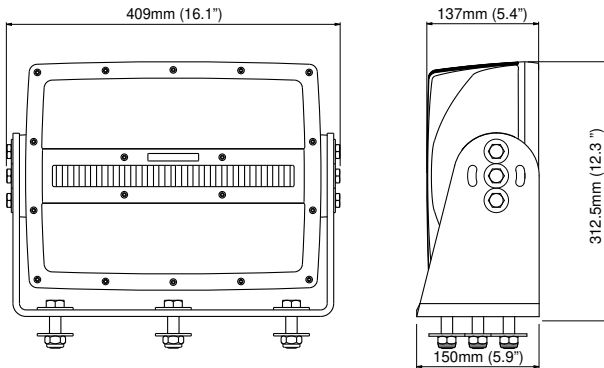

THE KING OF THE HILL

This majestic light has no less than 60 LEDs and weighs 18 kg. The Gemini is mostly used in the mining industry and on bucket-wheel excavators. However, with an output ranging from 13 800 to 25 200 lumens, it also sees use illuminating harbors, generally mounted on harbor masts.







TECHNICAL SPECIFICATIONS	GEMINI LED N4701	GEMINI LED N4702
Theoretical / Operational Lumens:	40300lm / 25200lm	30000lm / 19200lm
Color Temperature:	5700K	5700K
Nominal / Input Voltage DC:	24V / 18–32V	24V / 18–32V
Power Consumption:	300W	210W
Nominal Current:	12.5A@24V	8.8A@24V
Mount:	5 pcs Bolt M14x35	5 pcs Bolt M14x35
Connector:	2 x Built-in Deutsch DT-2 (2-pin)	2 x Built-in Deutsch DT-2 (2-pin)
EMC:	CISPR 25 Class 3, ISO 13766, ISO 14982, ISO 7637-2	CISPR 25 Class 3, ISO 13766, ISO 14982, ISO 7637-2
IP Rating:	IP68, IP6K9K, SAE J1455	IP68, IP6K9K
Weight:	18kg	18kg
Operating Temperatures:	-40°C... +85°C (Overheat protected)	-40°C... +85°C (Overheat protected)

LIGHT PATTERNS

N4701 25200lm High Beam

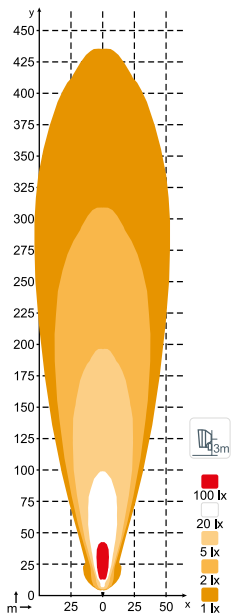

N4701 25200lm Flood

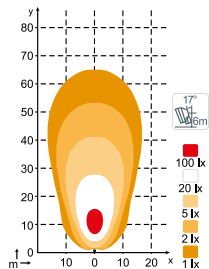

N4701 20160lm Diffused

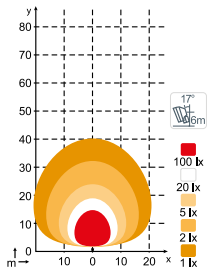

N4702, 19200lm High Beam

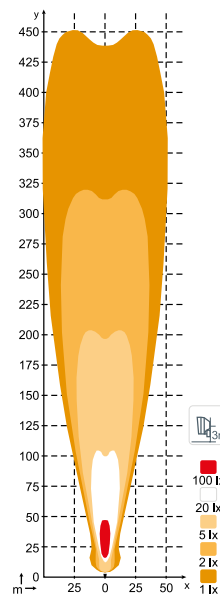

N4702, 19200lm Flood

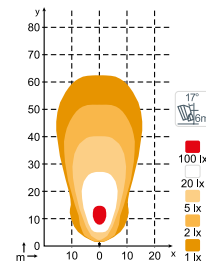

N4702, 15360lm Diffused

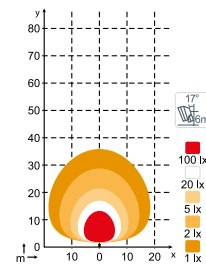



TECHNICAL SPECIFICATIONS	GEMINI LED N4703
Theoretical / Operational Lumens:	22000lm / 13800lm
Color Temperature:	5700K
Nominal / Input Voltage DC:	24V / 18–32V
Power Consumption:	240W
Nominal Current:	10.0A@24V
Mount:	5 pcs Bolt M14x35
Connector:	2 x Built-in Deutsch DT-2 (2-pin)
EMC:	CISPR 25 Class 3, ISO 13766, ISO 14982, ISO 7637-2
IP Rating:	IP68
Weight:	18kg
Operating Temperatures:	-40°C... +85°C (Overheat protected)

LIGHT PATTERNS

N4703 13800lm
Pencil Beam

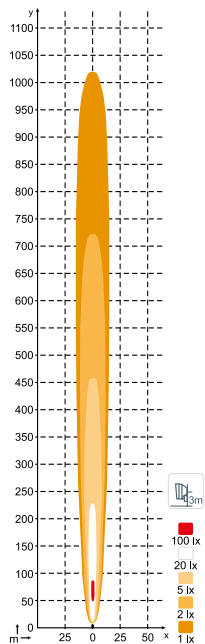

N4703 13800lm
High Beam

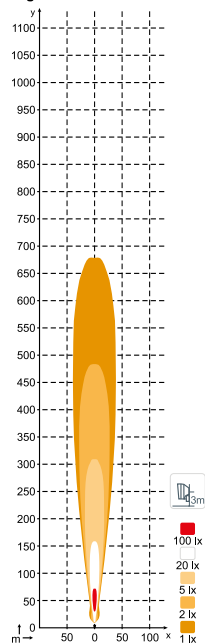

N4703 11040lm
Diffused

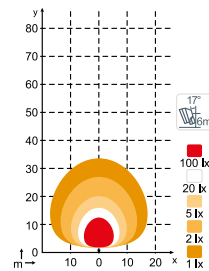

PICTOR PRO 830

MEASUREMENTS

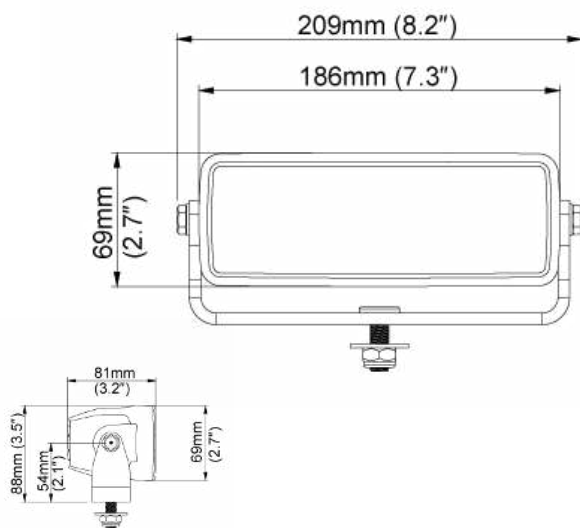

JUST FLIP IT

The Pictor PRO 830 is here to become your new favorite work light. This adaptable light has a 180-degree tilt angle thanks to the smart design of the hard-wearing u-bracket. The low-profile Pictor PRO 830 is equipped with an asymmetric Wide Flood light pattern, making it truly versatile while giving you several different options for illumination, depending on the orientation of the intended point of fixture. Mount horizontal or vertical for different light patterns, and/or flip to suit your application. The tempered glass lens and tough aluminum body provides this heavy-duty work light with excellent resistance against the elements.



TECHNICAL SPECIFICATIONS	PICTOR PRO 830
Theoretical / Operational Lumens:	4800lm / 3000lm
Color Temperature:	5000K
Nominal / Input Voltage DC:	12V, 24V / 9–16V, 18–32V (Dimmable)
Power Consumption:	46W
Nominal Current:	1.6A@24V / 2.9A@12V
Mount:	Single Bolt M10
Connector:	Built-in Deutsch DT-2 (2-pin)
EMC:	CISPR 25 Class 5, ISO 13766, ISO 14982, ISO 7637-2
Electronics:	Isolated
Shock:	60G
Vibration:	15.3Grms 24–2000Hz
Lens:	Glass
IP Rating:	IP68, IP6K9K
Weight:	1.3kg
Operating Temperatures:	-40°C... +85°C (Overheat protected)



LIGHT PATTERNS

Pictor PRO 830, 3000lm
Wide Flood RH (Asymmetric)

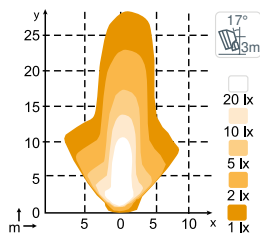

Pictor PRO 830, 3000lm
Wide Flood (Asymmetric)

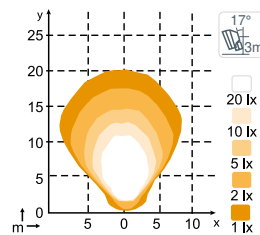

PICTOR 620

MEASUREMENTS

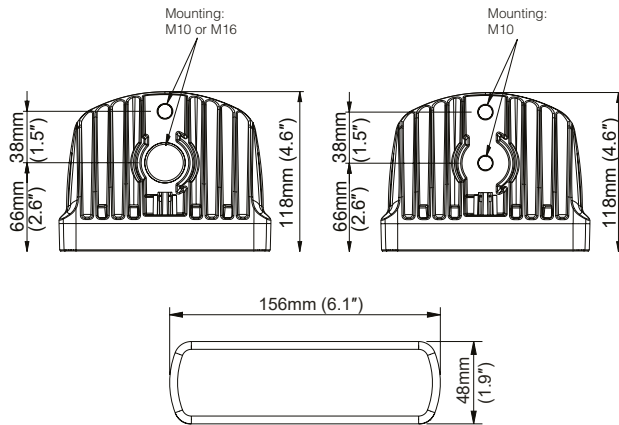

EXTREME PRECISION LIGHTING

With this you'll be sure to hit the bullseye. Pictor 620 is designed to be mounted on equipment booms or vehicle bodies for optimized and targeted illumination of a specific work area. Thanks to its compact and clever design, this low-profile work light is unbeatable in durability, able to withstand roughness along its edges and the odd bump in the corners. The mechanical, thermal and corrosion resistance of Pictor 620 is excellent. Used in the construction, forestry and mining industries, it is particularly suitable for excavators, telehandlers and other equipment with a boom.

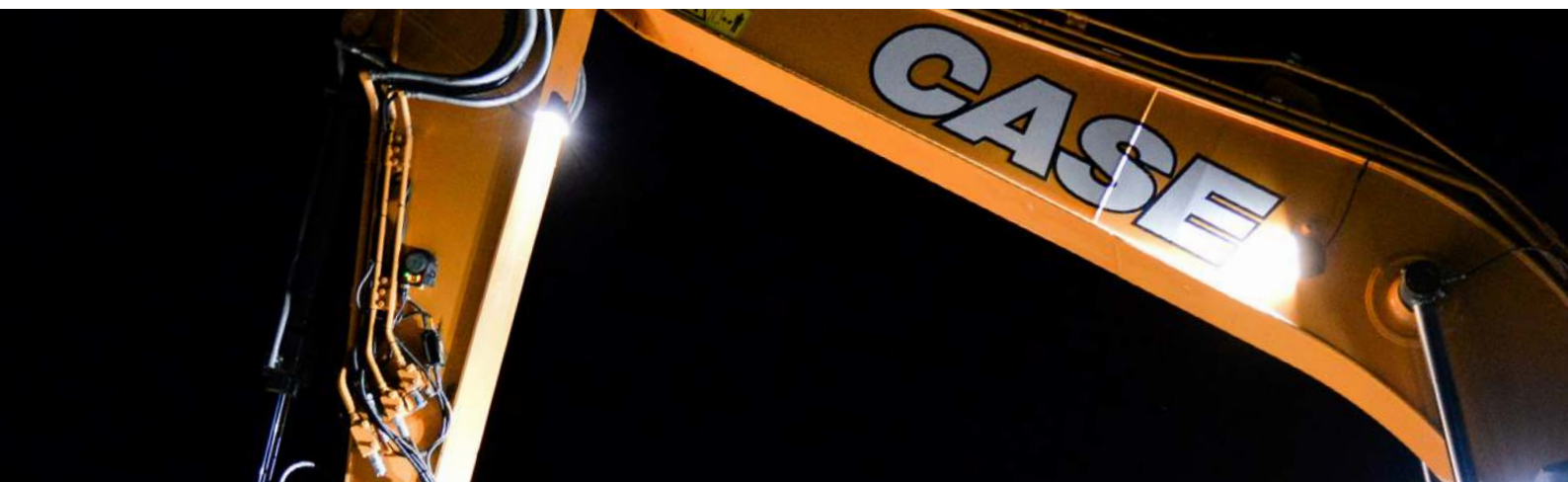

TECHNICAL SPECIFICATIONS	PICTOR 620
Theoretical / Operational Lumens:	2700lm / 1800lm
Color Temperature:	5000K
Nominal / Input Voltage DC:	12V, 24V / 9–16V, 18-32V (Dimmable)
Power Consumption:	28W
Nominal Current:	1.0A@24V / 2.0A@12V
Mount:	M10 or M16
Connector:	Built-in Deutsch DT-2 (2-pin)
EMC:	CISPR 25 Class 5, ISO 14982, ISO 13766, ISO 13309, ISO 11452-2, ISO 7637-2, EN 61000-4-2, ISO 14982, EN 12985
Electronics:	Isolated
Shock:	60G
Vibration:	15.3Grms 24–2000Hz
Lens:	Grilamid® (registered trademark of EMS-GRIVORY)
IP Rating:	IP68, IP6K9K
Weight:	0.7kg
Operating Temperatures:	-40°C... +85°C (Overheat protected)



TT DS (Top Top)
Light Pattern: Downstream



TD US (Top Down)
Light Pattern: Upstream



LIGHT PATTERNS

**Pictor 620, 1800lm
Flood LH US**

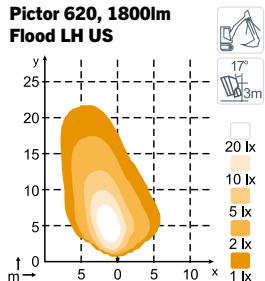

**Pictor 620, 1800lm
Flood RH US**

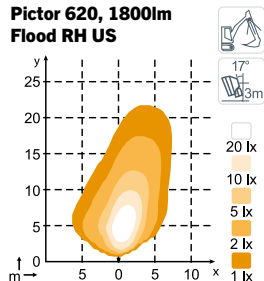

**Pictor 620, 1800lm
Flood TD US**

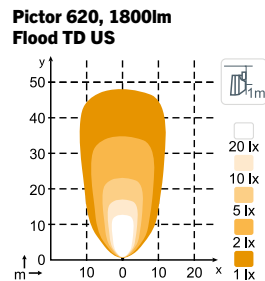

**Pictor 620, 1800lm
Flood TT DS**

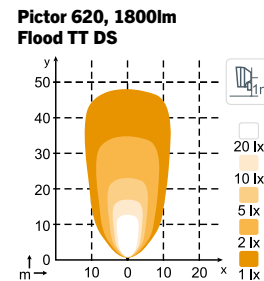

TAURUS

MEASUREMENTS

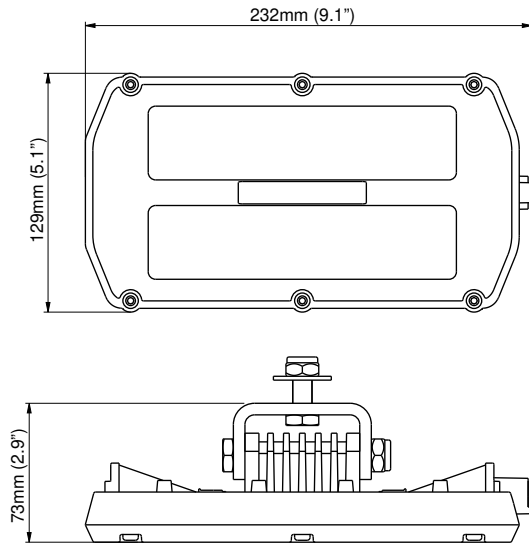

NO BLIND SPOTS

Ideal for illuminating short distances, the Taurus is used primarily in engine rooms. A white plastic cover ensures that those working in its beam will not be blinded. The light pattern is designed to minimize shadows. The Taurus has no less than 54 LEDs and a light output of 1950 lumens.



TECHNICAL SPECIFICATIONS	TAURUS LED N7201
Theoretical / Operational Lumens:	3100lm / 1950lm
Color Temperature:	5700K
Nominal / Input Voltage DC:	12–24V / 9–32V
Power Consumption:	30W
Nominal Current:	1.25A@24V / 2.5A@12V
Mount:	Single Bolt M10
Connector:	Built-in Deutsch DT-2 (2-pin) (left or right)
EMC:	CISPR 25 Class 3, ISO 13766, ISO 14982, ISO 7637-2
Shock:	60G
Vibration:	15.3Grms 24–2000Hz
IP Rating:	IP68, IP6K9K, SAE J1455
Weight:	1.3kg
Operating Temperatures:	-40°C... +85°C (Overheat protected)



LIGHT PATTERNS

N7201 1950lm
Diffused

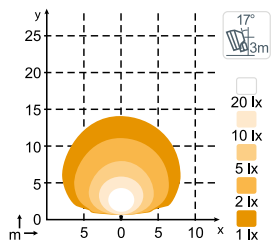

VELA

MEASUREMENTS

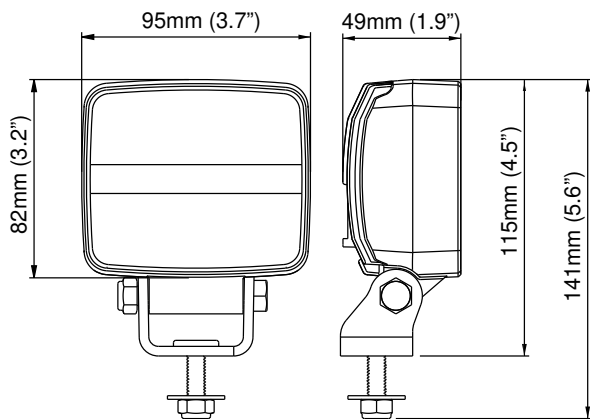

STATE-OF-THE-ART WARNING LIGHT

Vela is our innovative safety light that uses isolated, integrated electronics as the cornerstone of its performance. With its light output of 150 lumens and wavelength of 470 nanometers, it produces a focused blue light that is very useful for illuminating dangerous situations. Whether used on a forklift in a warehouse as an early warning light for approaching vehicles or as a warning light on a tractor, you can be assured that this premium light will fulfil its purpose, making your work environment safer and more efficient.

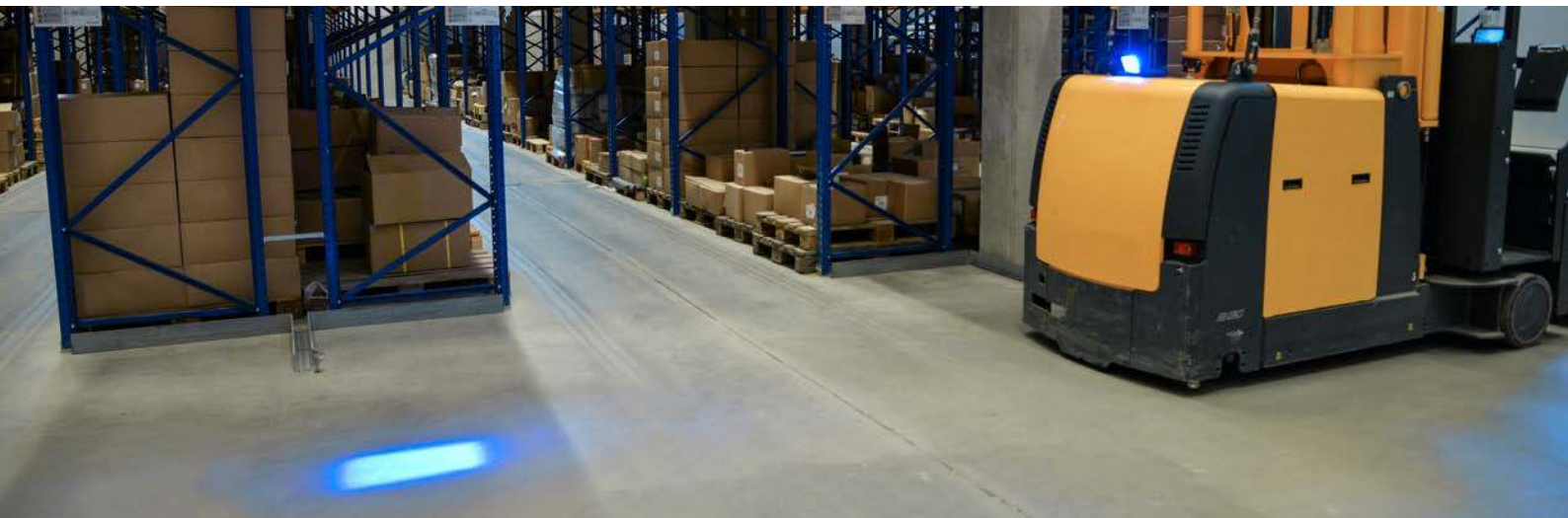

TECHNICAL SPECIFICATIONS	N2201 BLUE
Light Color:	Blue (470nm)
Nominal / Input Voltage DC:	12–48 V / 9–68V
Power Consumption:	16W
Nominal Current:	0.3A@48V / 0.7A@ 24V / 1.4A@12V
Mount:	Single bolt M8
Connector:	Built-in Deutsch DT-2 (2-pin)
EMC:	CISPR 25 Class 5, EN12895, ISO 13766, ISO 14982, ISO 7637-2
Electronics:	Isolated
Shock:	60G
Vibration:	8Grms 24–2000Hz
Weight:	0.5kg
Operating Temperatures:	-40°C... +85°C (Overheat protected)



LIGHT PATTERNS

N2201

Spot

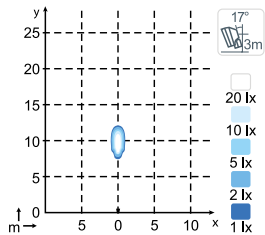

CORONA 400

MEASUREMENTS

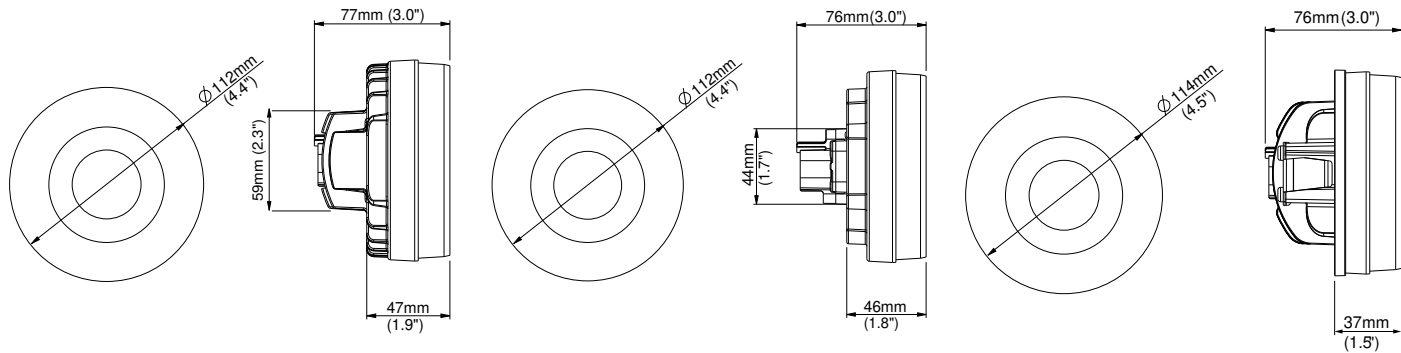

THE CONTEMPORARY TAIL LIGHT

The Corona 400 delivers four functions: direction indicator, position light, stop light and reverse light, and is the first LED tail light on the market that integrates all four functions in one unit. Thanks to its funky and compact design, this low-profile tail light is both good-looking and durable. With the Corona 400 you'll get the automotive look, but with heavy-duty standards and a vibration resistance capacity of 15.3 Grms.



*External cooling needed

TECHNICAL SPECIFICATIONS	CORONA 400	CORONA 400 INTEGRATED	CORONA 400 SNAP-IN
Nominal / Input Voltage DC:	12V, 24V / 9–32V	12V, 24V / 9–32V	12V, 24V / 9–32V
Power Consumption: 12 / 24 V	Direction indicator 21W Position light 0.2 / 0.5W Stop light 1.5 / 3.0W Reverse light 2.0 / 4.0W	Direction indicator 21W Position light 0.2 / 0.5W Stop light 1.5 / 3.0W Reverse light 2.0 / 4.0W	Direction indicator 21W Position light 0.2 / 0.5W Stop light 1.5 / 3.0W Reverse light 2.0 / 4.0W
Nominal current: 12 / 24 V	Direction indicator 1.5A / 0.75A Position light 15 mA Stop light 110 mA Reverse light 130 mA	Direction indicator 1.5A / 0.75A Position light 15 mA Stop light 110 mA Reverse light 130 mA	Direction indicator 1.5A / 0.75A Position light 15 mA Stop light 110 mA Reverse light 130 mA
Mount:	3 pcs screw M4	3 pcs screw M4	Snap-in
Connector:	Built-in Deutsch DT-6 (6-pin)	Built-in Deutsch DT-6 (6-pin)	Built-in Deutsch DT-6 (6-pin)
EMC:	CISPR 25 Class 5, EN 13309, EN 61000-4-2, ISO 14982-2, ISO 13766, ISO 11452, ISO 7637-2, ISO 10605	CISPR 25 Class 5, EN 13309, EN 61000-4-2, ISO 14982-2, ISO 13766, ISO 11452, ISO 7637-2, ISO 10605	CISPR 25 Class 5, EN 13309, EN 61000-4-2, ISO 14982-2, ISO 13766, ISO 11452, ISO 7637-2, ISO 10605
Approvals:	ECE	ECE	ECE
Electronics:	Isolated	Isolated	Isolated
Shock:	60G	60G	60G
Vibration:	15.3Grms 24–2000Hz	15.3Grms 24–2000Hz	15.3Grms 24–2000Hz
IP Rating:	IP68, IP6K9K	IP68, IP6K9K	IP68, IP6K9K
Weight:	0.5kg	0.5kg	0.5kg
Operating Temperatures:	-40°C... +85°C (Overheat protected)	-40°C... +85°C (Overheat protected)	-40°C... +85°C (Overheat protected)



DORADO

MEASUREMENTS

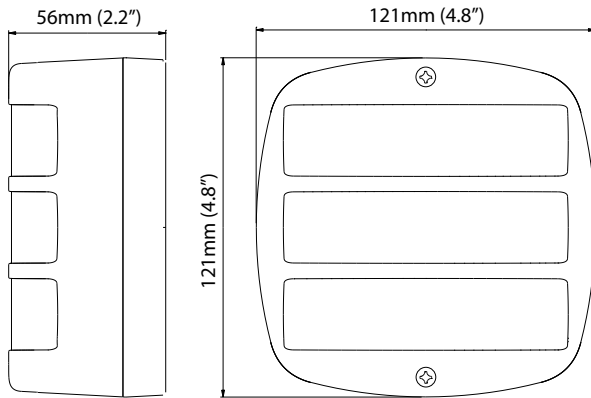

THE VERSATILE LIGHT

We aim for versatility. This tail light combines tail, stop, and indicator lights all in one unit and can be mounted on most vehicles. Mounting is a snap since this is a tell-tale compatible light, just plug & play. The Dorado is durable against both vibration and shock.



TECHNICAL SPECIFICATIONS	DORADO N70
Nominal / Input Voltage DC:	12V, 24V / 8–32V
Power Consumption:	Brake 1.4W Indicator 1.4W Tail 0.4W Tell-tale 24V: Indicator 18W
Nominal Current at 12V:	Brake 116mA Indicator 116mA Tail 34 mA
Nominal Current at 24V:	Brake 58mA Indicator 58mA Tail 17mA Tell-tale: Indicator 750mA
Mount:	M6x25 2pcs
Connector:	4 pin Male Terminal 6.3 x 0.8
EMC:	EN 12895, ISO 13766, ISO 14982, ISO 7637-2
Electronics:	Isolated (Epoxy Encapsulated)
Shock:	60G
Vibration:	20Grms 24–2000Hz
Weight:	0.4kg
Operating Temperatures:	-40°C... +85°C (Overheat protected)



BUMBLEBEE

MEASUREMENTS

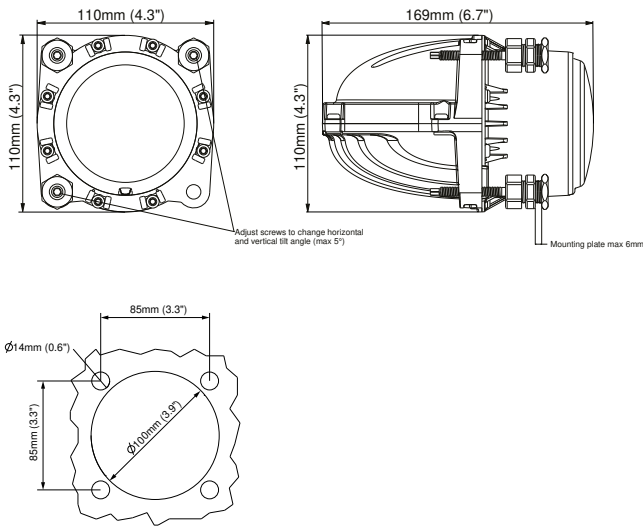

THE BUZZER

The Bumblebee headlight module delivers an even, streak-free light pattern that greatly improves the driver's vision. This ECE-approved headlight module comes in high beam and low beam versions, specifically designed and optimized for heavy-duty vehicles. Thanks to the well-balanced color temperature, the driver will stay alert longer. The Bumblebee's exceptional light output in combination with the long light range places it among the top of the currently available options on the market.



TECHNICAL SPECIFICATIONS	BUMBLEBEE
Color Temperature	5800K
Nominal / Input Voltage DC:	12V, 24V / 9–32V
Power Consumption: 12 / 24 V	High Beam 17W Low Beam 17W
Nominal current: 12 / 24 V	High Beam 0.75A @24V / 1.5A@12V Low Beam 0.75A @24V / 1.5A@12V
Mount:	3 pcs M6 Screw
Connector:	Built-in Deutsch DT-2 (2-pin)
EMC:	CISPR 25 Class 5, ISO 13766, ISO 14982, ISO 7637-2, ISO 10605, ISO 11452, EN 61000-4-2, EN 13309
Approvals:	ECE
Electronics:	Isolated
Shock:	60G
Vibration:	6Grms 24-2000Hz
IP Rating:	IP68, IP6K9K
Weight:	0.95kg
Operating Temperatures:	-40°C... +85°C (Overheat protected)



LIGHT PATTERNS

**Bumblebee
High Beam**

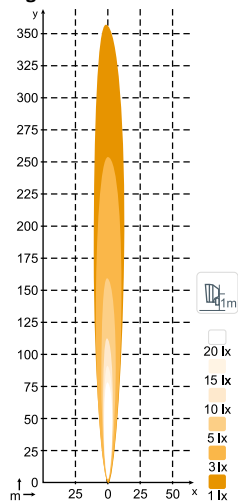

**Bumblebee
Low Beam, RHT**

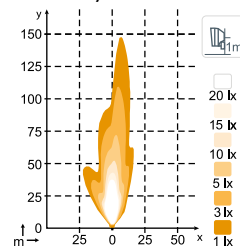

**Bumblebee
Low Beam (Symmetric)**

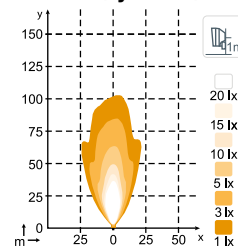

CUE

MEASUREMENTS

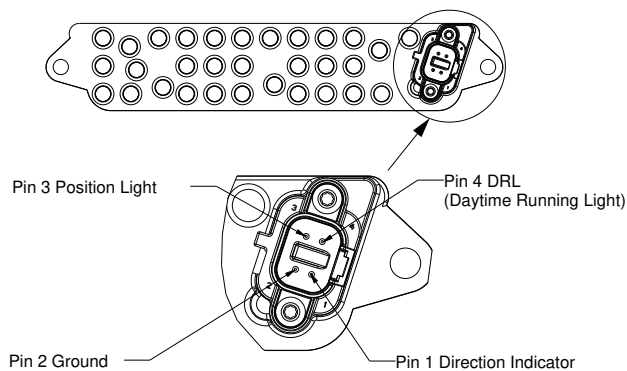
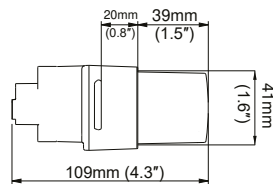
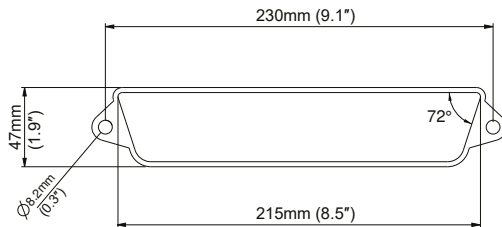

THE HEAD-TURNER

The CUE is a cool front combination light giving you the design freedom you need. All set for future demands, this front light combines a daytime running light, position light and direction indicator into a sleek package with a soft, even light. CUE's ingenious 360° cooling system makes it the world's first front combination light suitable for mounting at any vertical angle. Look stylish and remain visible on and off the road with the ECE-approved CUE.

TECHNICAL SPECIFICATIONS	CUE
Operational Lumens Output:	500lm DRL
Nominal / Input Voltage:	24V / 18–32V
Power Consumption 28V:	DRL 11W Position light 2W Direction indicator 15W
Nominal Current:	DRL 0.45A Position light 0.06A Direction indicator 0.6A
Mount:	2 pcs M8 Screw
Connector:	Built-in Deutsch DT-4 (4-pin)
EMC:	CISPR 25 Class 5, ISO 13766, ISO 14982-2, ISO 7637-2, ISO 10605, ISO 11452, EN 61000-4-2, EN 13309
Approvals:	ECE
Electronics:	Isolated
Shock:	60G
Vibration:	9.8Grms 24-1000Hz
Weight:	0.5kg
Operating Temperatures:	-40°C... +85°C (Overheat protected)



SCULPTOR

MEASUREMENTS

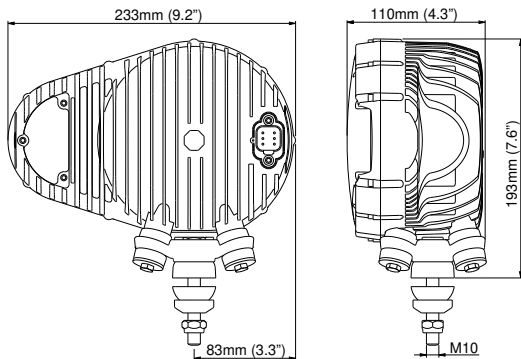
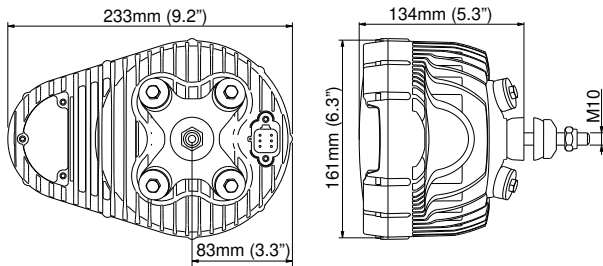

ALL-IN-ONE DURABLE HEADLIGHT

The Sculptor driving light integrates headlight, indicator, and parking lights in one unit. Unbeatable in its durability, this light is equipped with our integrated QUAKE dampening system. The combination headlight withstands shocks of 60G and vibration of 15.3 Grms at 24–2000 Hz. This combination light with pedestal or rear mounting is very useful in agricultural, construction, and trucking applications. It has a dual-beam function with both dipped and full beams, which offers any vehicle using this light an amazing advantage.





TECHNICAL SPECIFICATIONS	SCULPTOR N6001 QD	SCULPTOR LED N6002 QD
Color Temperature:	5700K	5700K
Nominal / Input Voltage DC:	12–24V / 9–32V	12–24V / 9–32V
Power Consumption: 12 / 24V	High Beam 34W, Low Beam 17W, Park 2.7W, Indicator 17.5W	High Beam 34W, Low Beam 17W, Park 2.7W, Indicator 17.5W
Nominal Current: 12 / 24V	High Beam 1.4A@24V / 2.8A@12V Low Beam 0.7A@24V / 1.4A@12V	High Beam 1.4A@24V / 2.8A@12V Low Beam 0.7A@24V / 1.4A@12V
Mount:	Single Bolt M10	Single Bolt M10
Connector:	Built-in Deutsch DT-6 (6-pin)	Built-in Deutsch DT-6 (6-pin)
EMC:	CISPR 25 Class 3, EN 13309, EN 61000-4-2, ISO 14982-2, ISO 13766, ISO 11452, ISO 7637-2, ISO 10605	CISPR 25 Class 3, EN 13309, EN 61000-4-2, ISO 14982-2, ISO 13766, ISO 11452, ISO 7637-2, ISO 10605
Approvals:	ECE	ECE
Shock:	60G	60G
Vibration:	15.3Grms 24–2000Hz	15.3Grms 24–2000Hz
IP Rating:	IP68, IP6K9K, SAE J1455	IP68, IP6K9K, SAE J1455
Weight:	2.5kg	2.5kg
Operating Temperatures:	-40°C... +85°C (Overheat protected)	-40°C... +85°C (Overheat protected)

LIGHT PATTERNS

N60XX ECE
High Beam RHT

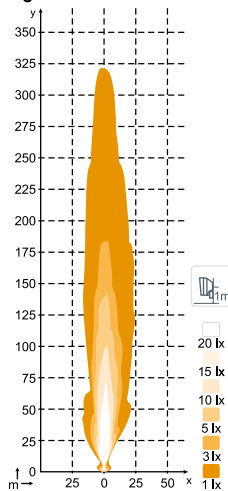

N60XX ECE
High Beam LHT

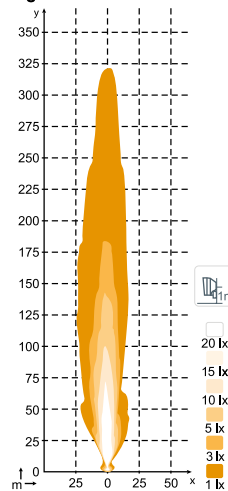

N60XX ECE
Low Beam RHT

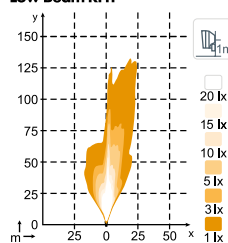

N60XX ECE
Low Beam LHT

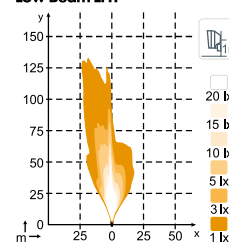

ECE Approvals:

Passing beam: ECE Regulation 112,
class B for right & left hand traffic
Driving beam: ECE Regulation 112,
class B, Reference number 25
Position light: ECE Regulation 7
Direction Indicator: ECE Regulation 6, class 1b (front)
Direction Indicator: ECE Regulation 6, class 5 (side)

FRONT LIGHTS



PRODUCTS	N523 LED	N520 LED	N503 LED	N500 LED
Approvals:	ECE	ECE	ECE	ECE
Bulb:	H4	H4	H4	H4
Watt & Voltage:	60/55W@12V, 75/70W@24V	60/55W@12V, 75/70W@24V	60/55W@12V, 75/70W@24V	60/55W@12V, 75/70W@24V
Light Pattern:	High/Low Beam	High/Low Beam	High/Low Beam	High/Low Beam
Mount:	M10	M10	M10	M10
Electronics:	Isolated	Isolated	Isolated	Isolated
Vibration Dampening:	D	–	D	–



PRODUCTS	N523 HALOGEN	N520 HALOGEN	N503 HALOGEN	N500 HALOGEN
Approvals:	ECE	ECE	ECE	ECE
Bulb:	H4	H4	H4	H4
Watt & Voltage:	60/55W@12V, 75/70W@24V	60/55W@12V, 75/70W@4V	60/55W@12V, 75/70W@24V	60/55W@12V, 75/70W@24V
Light Pattern:	High/Low Beam	High/Low Beam	High/Low Beam	High/Low Beam
Mount:	M10	M10	M10	M10
Vibration Dampening:	D	–	D	–

Connectors: Pigtail Deutsch 6-pin, Built-in AMP 6-pin, Built-in Deutsch 6-pin, Grommet



PRODUCT INFORMATION

Not all products are available in all markets. During continuous improvement specifications and design can change. All values are nominal values. Illustrations do not necessarily show the design of every version and some features are version specific. The lumens output varies depending on lens color.

WARRANTY

For full details of warranty terms and conditions, please visit: <https://www.nordiclights.com/terms-conditions/>

ABBREVIATIONS

D	Dampening
ECE	European Unicon Traffic Regulations
DS	Downstream
F	Flushmount
G	Generation
H	Handle
HS	Handle & Switch
LH	Left Hand Mount
QD	Quake Dampening
R	Reverse
RH	Right Hand mount
S	Side mount
SAE	USA Traffic Regulations
SD	Super Dampening
SP	Single Power
TD	Suspended Pedestal mount (Top Down)
TP	Twin Power
TT	Upright Pedestal mount (Top Top)
US	Upstream
V	Version
XD	Extreme Heavy Duty Dampening
PH	Phenom Optics





Authorized Distributor:



Tel: +971 4 880 1252

Email: inquiries@gulfminetech.com

W: www.gulfminetech.com



HEAD OFFICE

Nordic Lights Ltd.
Bennäsvägen 155
P.O. Box 36
FI-68601 Jakobstad
Finland
www.nordiclights.com
Tel. +358 20 1345 100
Fax +358 20 1345 108

GERMANY

Herrmans Nordic Lights GmbH
Wilhelmstr. 5
59439 Holzwickede
Germany
Tel +49 2301 919787 13
Fax +49 2301 919787 26

USA

Nordic Lights NA, Inc.
PO Box 3448
Boardman, OH 44513-3448
USA
Tel +1 262 215 6930

BRAZIL

Nordic Lights Brazil
Rua Aiuruoca N:o 95, Apt 102B
Belo Horizonte- Minas Gerais
CEP 31.910-130
Brazil
Tel +55 31 9 9885-2564

CHINA

苏州拉普照明有限公司
Nordic Lights (SuZhou) Co.,Ltd
苏州工业园区葑亭大道598号2号厂房
No.598 2# Fengting Avenue SIP Jiangsu
China
电话 0512-62535860, 0512-62535861
Tel 0512-62535860, 0512-62535861
传真 0512-62535862
Fax 0512-62535862

